

853 Series

MANUAL

E L E C T R I C S C O O T E R

INITIAL RIDING IT

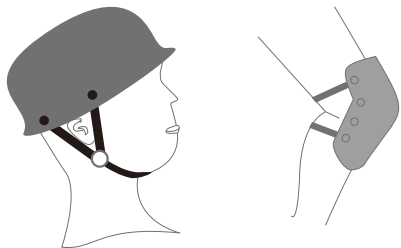

During learning, risk of slip hurt occurs, so wear helmet and protectives during trying it. Refer to image.

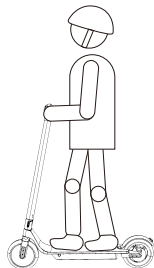
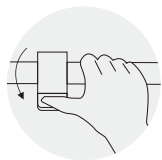

- 2 When sliding smoothly and balanced, retreat the other foot and put on the board, then press the acceleration button to fasten scoot forward.

The above learning step is intended for use of initializing ride .for further information , refer to <MANUAL FOR ELECTRIC SCOOTER> mentioned above.



SPECIAL HINTS

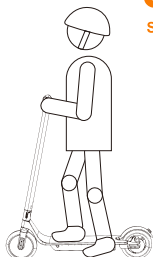

- 1 Turn power on, foot step on the scooter board, the other foot kick against ground backward.

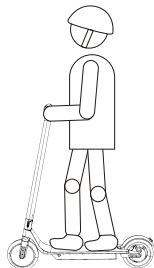

- 3 During running, touch the button of " Ⓧ ", switch over speed. If the light is not strong at night, turn on light, keep the road bright.

CAUTIONS

FAILURE TO OBSERVE WILL LEAD TO TROUBLES , ACCIDENTS, EVEN PHYSICAL SAFETY OR PROPERTY DAMAGES



WARNING

SPECIAL HINTS :

When folding scooter, be sure to align Up Arrow to Down Arrow

SPECIAL REMIND FOR CLEANING :

1. Prevent water from entering front part of scooter,controller, recharge socket(with battery and circuit)
2. No high pressure water gun to flush scooter
3. No riding the scooter in the rain.

SPECIAL HINTS FOR RIDING

1. To ensure the safety, wear protectives before riding scooter.
2. Electric scooter is fashionable entertainment vehicle., no riding onto motor vehicle lane.
3. Beginner should be under custody to learn to ride.
4. Not operate the outfit until being familiar with the scooter.

RECOMMENDATIONS FOR RECHARGING

1. No using non-original Scooter charger to recharge the battery
2. No recharging when the socket is wet.
3. No recharging within reach of children and pets
4. No recharging around flammable and combustible items
5. No exposure to the place higher than 50℃ or lower than -20℃(I.E. not exposed to rain or sunshine).
No disposing of the battery pack into fire, or exposion occur or flames or fail in effect. If to be un-used beyond 30 days, have it fully charged beforehand, then store it in cool & dry place. Please recharge it every 60 days to protect the battery from damage.
6. Avoid recharging without supervision.
7. No disassembling battery pack.
8. The scooter with full battery can stand by for 120 or 180 days long. With non-full battery energy, can standby 30—60 days. And be careful, not recharging in time will damage battery pack.

WELCOME TO USE

Thank you for choosing our electric scooter (hereinafter referred to as electric scooter), which is a fashionable sports and entertainment equipment.

CONTENTS

1.Product & accessories-----	02
2.Function diagram-----	03
3.Scooter body assembly chart-----	04
4.Recharger connection-----	05
5.How to run it -----	05
6.Safety knowledge-----	07
7.How to fold and handle it-----	12
8.Routine maintenance and repair-----	13
9.Model & parameters-----	14
10.Descriptions of harmful material-----	15
11.Declarations for trademarks and law-----	15
12.Warranty-----	16
13.Declarations for law-----	20

1. PRODUCT & ACCESSORIES

Whole view

major contents:
instruction, law declaration, prompt card

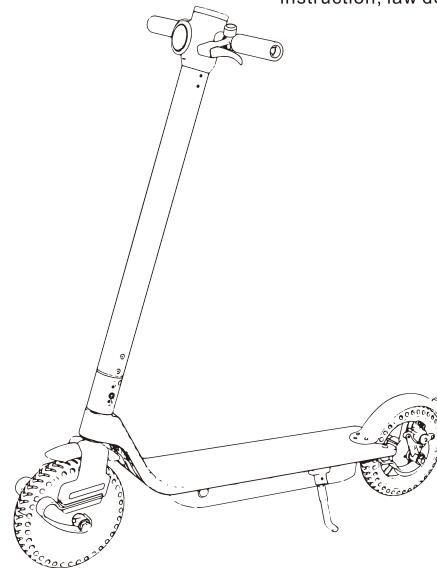

Accessories

Charger

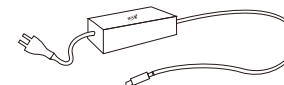

Check if the items are complete in package, Please contact us if any items missed (please refer to bottom page)

2. FUNCTION DIAGRAM

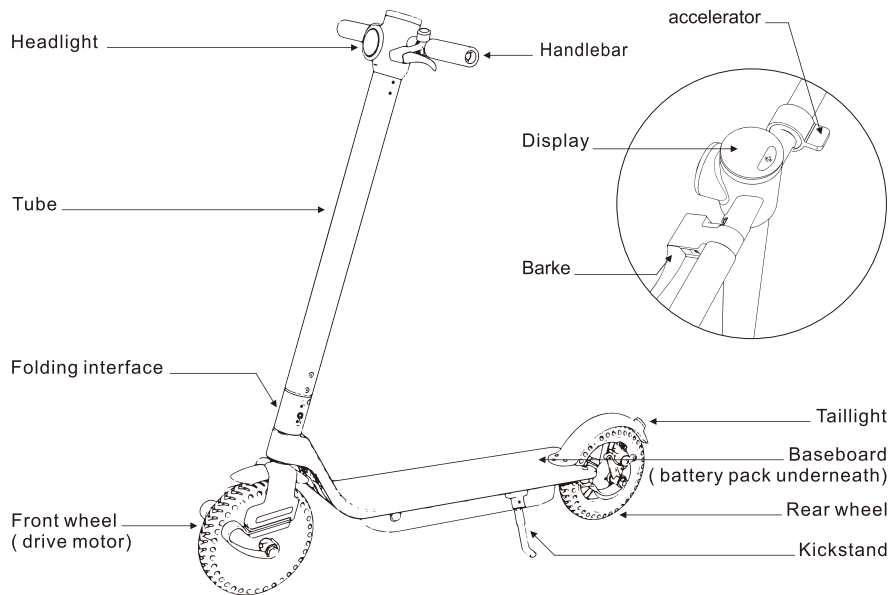

Display&App

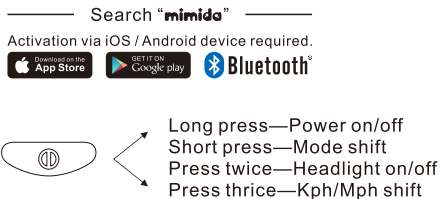
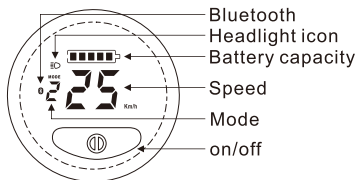

3. SCOOTER BODY ASSEMBLY FLOW CHART

1. Folding chart rollout:

Press folding stopper to the direction of arrow 1. sway the tube up and down slightly, and raise it to the direction of arrow 2, then stuck it firmly.

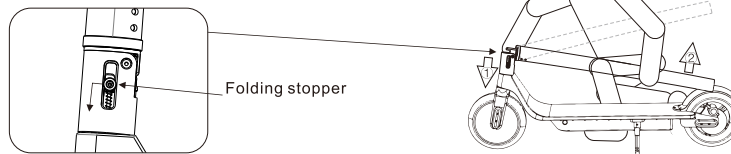

2. Take the scooter out from the box for installation:

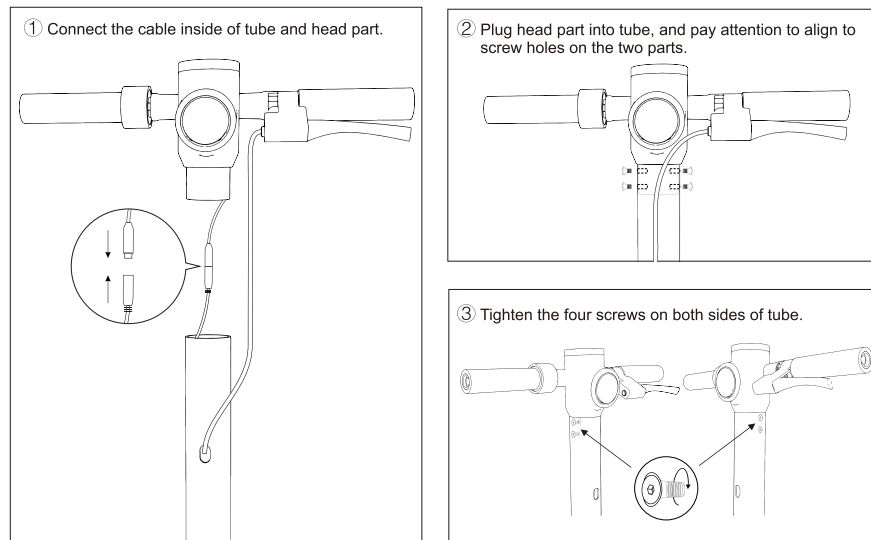

4. CONNECTION OF CHARGER

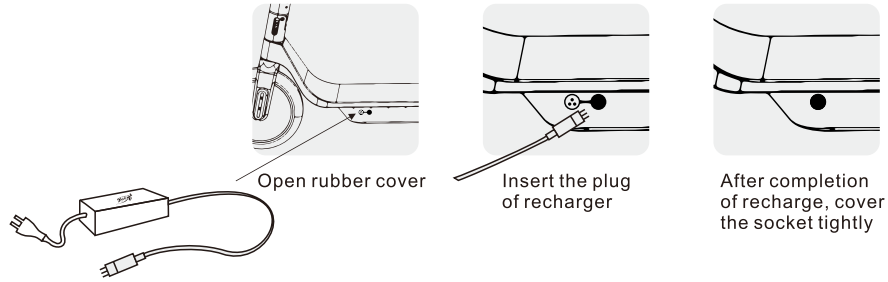

5. LEARN TO DRIVE

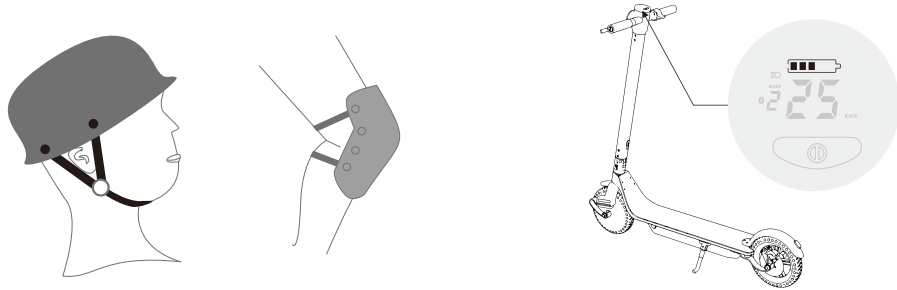

Due to the possibilities of hurt occur during riding on scooter, please wear protective such as helmet.

1. power it on, and check battery level.



2. single foot steps on scooter board, then the other foot kicks against ground backward.

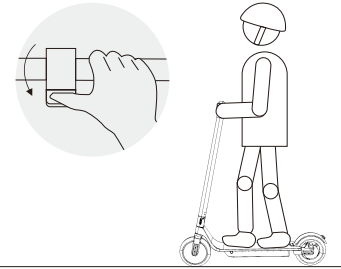

3. wait to smoothly run, retreat the foot and step on board. Balance yourself to turn accelerating throttle to speed up.

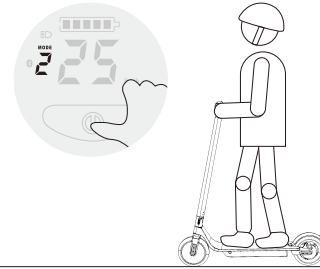

4. during running, touch " **ⓘ** " button to shift speed. When it is dark or weak light, open front light to keep road bright.

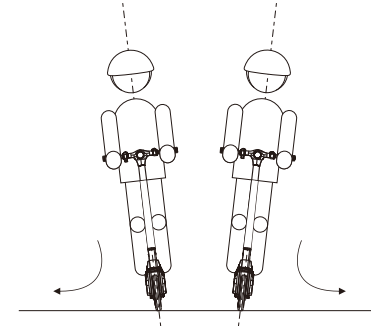

5. when turning around in corner, keep body gravity center slightly toward to side of corner, and turn the handle slowly.

6 . COMMON SAFETY KNOWLEDGE

To keep away from potential danger

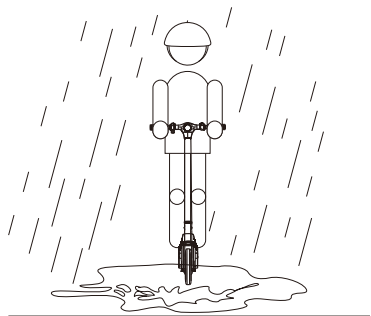

! No riding in the rain

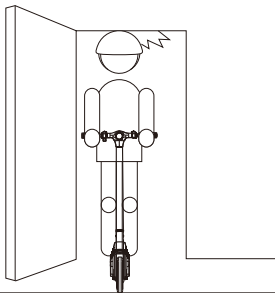

! Avoid bumping your head against door frame



! When crossing deceleration strip, pit, concave etc, no slow down to pass. When on curve road, keep speed at 5—10kilo. Bend your knee a little to cope with rough road.

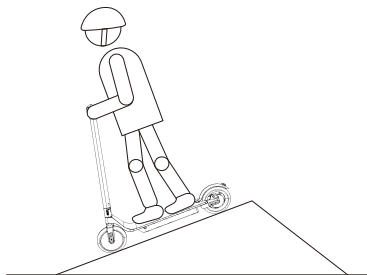

! Do not accelerate the scooter on a downward slope

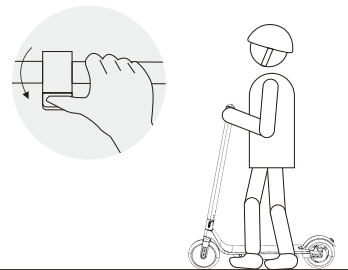

! When pushing the scooter to run, no pressing the accelerator .

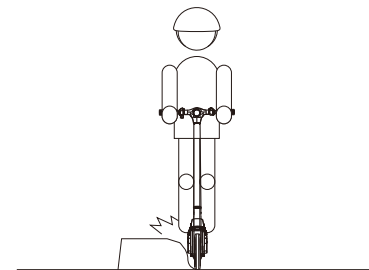

! Avoid the obstacles

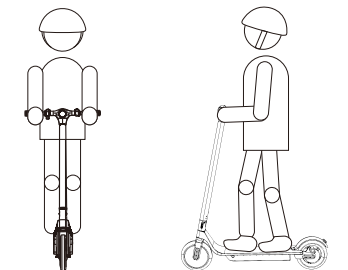

! No place the bag or weighties on handle. No run on slippy marble,tile to prevent slip down.

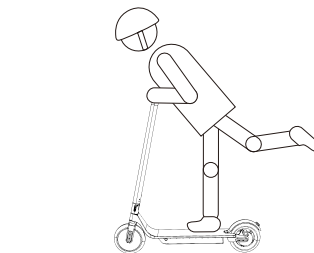

! When riding, no laying with only one foot.

NO TRYING DANGEROUS ACTIONS

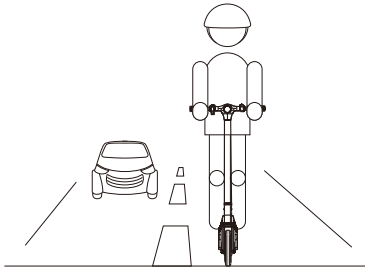

⚠ No riding scooter on motor vehicle lane.

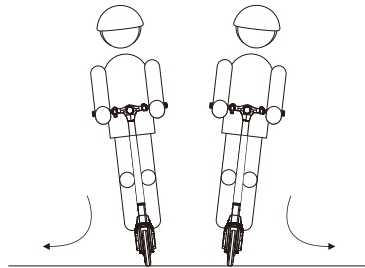

⚠ When riding at high speed, do not turn handle bar in big angle.



⚠ No riding in water beyond 5cm deep.

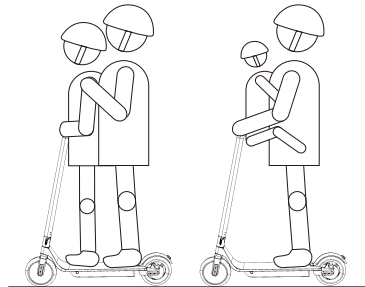

⚠ Never multiple persons ride the same scooter or holding baby to ride scooter.

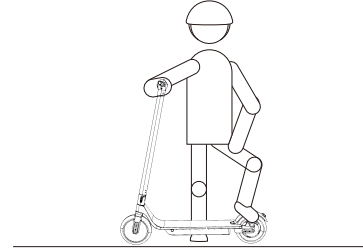

⚠ No treading on rear fender

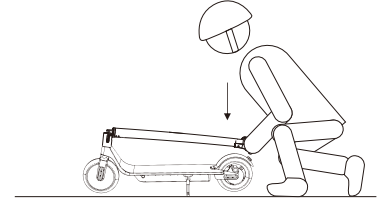

⚠ No strongly press the handle

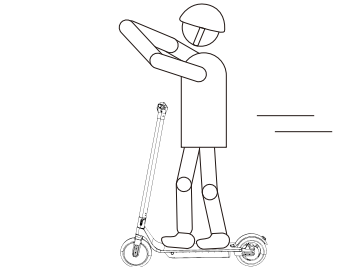

⚠ No riding without holding handle

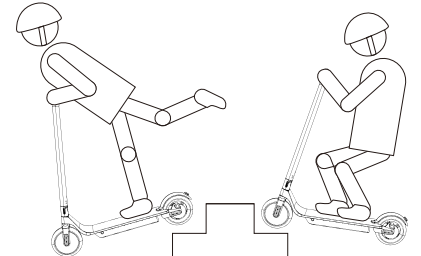

⚠ No riding on stairs or jumping over obstacles.

Safety Precautions

- The scooter is an entertainment outfit. But when in public area, it comes with transport properties. So it is connecting with dangers of common transportation tools. Please strictly observe the relevant rule or regulations to ensure your personal and property safety.
- Pay attentions: once in public area, even though you obey local rules, maybe you also will be involved in trouble and risk led by other vehicles. So your vigilance should be raised. Keep away from other tools ,or take care of riding on unfamiliar road.
- Respect the right of other pedestrians. Avoid frightening others, especially the elder & children, etc, behave politely. Pass through the left of passer(applicable to countries with the law that vehicles ride on the right side of the road. When coming cross walker, keep yourself in the right side and run at low speed.
- In absence of scooter regulations such as In China or other countries, please strictly obey the rules stipulated in manual. Or otherwise we have no obligations or responsibilities to be held for personal hurt, properties damages, etc.
- No lending the scooter to person who can not ride to avoid in-expectations. If it is lent to your friends, you will take responsibilities for them.
- Always check before you use it. If finding the components loose, obvious low battery level or excessive wear on tires, or fault turning, please stop use it. No abusing it. Or contact after-sales services for professional guidance.

7. FOLDING AND HANDLING

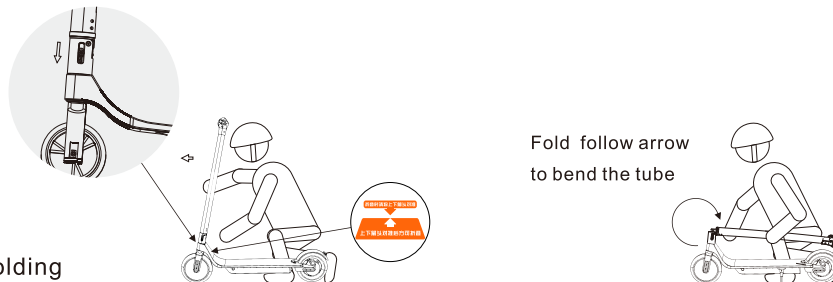

Folding

1. Be sure the scooter is powered off.
2. Upon aligning Up Arrow to Down Arrow to fold it.
3. Use the right hand to gently push vertical pipe forward.
4. The left hand press down folding lever.
5. Turn inward the vertical pipe to the lowest level.



Carrying

1. Handle when folding it, single hand or two hands handle the tube.

8. ROUTINE MAINTENANCE & REPAIR

Clean and store

Just use wet cloth to wipe off the dust or stains. If the it is solid dust, apply some toothpaste to wipe off it. If there is scratches on it, use the sand-cloth to gently wipe them .

Hints: no applying alcohol, petrol, etc soluble or corrosive material to clean it. When not recharging it, cover the jack to prevent water from into socket to lead to shorting or being damaged.

When being idle, store it indoors, dry and cool place. Avoid storing it outdoors for a long time. Harsh weather would shorten its service period.

Battery maintenance

- 1.no using other brand battery pack, or lead to potential danger or risk
- 2.no touching contacts of battery, no disassembling battery pack, or lead to explosion
- 3.just use the matching charger , or lead damages to your battery
- 4.properly dispose of battery to avoid polluting environment to obey the local rules.
5. in order to lengthen battery service life , always recharge it after using it

Be sure to store the battery under the environment of beyond 50℃ or lower than-20℃(I.E. no exposing scooter or battery pack to the strong sunshine or inside of hot car), No prohibiting the battery pack into fire, or lead to failure , overheat or fire. When being idle for more 30 days, recharge it full. Put it at dry cool place and recharge it every 60 days. If failing to do so, battery will be damaged, which is not include in the warranty scope.

Never recharge it before the battery drains out, recommend to recharge it every time you ride it.doing so will lengthen the life of battery. Under the normal temperature, the battery can perform perfectly; if riding it under lower than 0℃, the battery will not work badly. While under -20℃, the battery will acts half-perfectly better than in normal condition. With going up of temperature, batter restores capacity. For more details, refer to mileage display.

Hints: the full battery will drain out 120—180 days later. The flat battery should be on time recharged or put for long time and be damaged and not charged again. It does not fall into warranty. (notice: non- personnel is prohibited to repair unit, or will lead to electric shock or short, or serious accident)

9.MODEL AND PARAMETER

Spec.	Items	Parameters
Size	Before folding	110*43*110 (cm) L*W*H
	After folding	110*43*42 (cm) L*W*H
Weight	N.W.	Appr.13 (kg)
Requirements	Max load	120kg
	Suitable for age	18-45 years old
	Typical height	> 150cm
Main parameters	Max speed	25km/h
	Millage	30km
	Max slope	16%
	Road condition	Cement,asphalt flat dusty road, less than 3cm deep concave
	Operating T	-10~40 (°C)
	Storage temperature	-20~45 (°C)
	Water proof	IP65

1.scooter height: distance from ground to top of scooter; 2.typical travel: under condition of being full battery, 60kg load, temperature 25 centigrade ,flat ground, no wind blowing, at level 2,running at speed of 15Kilo the value measured under above condition. actual travel mileage will vary subject to actual conditon.

Notes: we have the right to alter the data or parameter without prior notice.

10.HAZARDOUS MATERIAL NAME/CONTENT

Index	Parameters of scooter					
	Pb	Hg	Cd	Cr(VI)	PBB	PBDE
Recharge	X	O	O	O	O	O
Battery	X	O	O	O	O	O
Socket	X	O	O	O	O	O
Main PCB	X	O	O	O	O	O
MeterPCB	X	O	O	O	O	O
Hub motor	X	O	O	O	O	O
Frame	O	O	O	O	O	O
Wheel	O	O	O	O	O	O

The table based on regulations of SJ/T11364
O: stand for harmful less than that in the even material of scooter(GB/T36572)
X: for harmful content more than that in some texture of material of scooter(GB/T26572)

11.WARRANTY POLICY

The aftersales service for scooter is strictly subject to <the law of the people's republic of China on the protection of consumers rights and interests>,<law of product quality of the people's republic of China> comes with contents below:

WARRANTY PERIOD

1. One year free repair
- 2.When the product fails, mail it to us for repair, or post it to designated service office.No detach it by yourself.
- 3.During warranty, show us relevant certificates such as guarantee card for free repair
- 4.Warranty scope means those failures under condition of normal riding it ,not intentionally damage, by man-made or natural disasters or abusing it.

Wonderful hints:

Since the package material is needed for safe transportation , recommend that the packaging material should kept for at least 15 days for free warranty

WARRANTY ITEMS

Part categories	Contents	Period	Pre-condition
Structure parts	Carbon fiber pipe	1 year	Breakage
	Carbon fiber pedal	1 year	Breakage
	Folding combination	1 year	Deformation
	Front fork combination	1 year	Deformation,breakage
	Metal head frame	1 year	Deformation,breakage
	Detachable handle	1 year	Deformation,breakage under normal riding
Electrical parts	Front hub	1 year	Deformation,breakage under normal riding
	Drive motor(rear hub)	1 year	Failure
	Controller assembly	1 year	Failure
	Instrument assembly	1 year	Failure
	Dial controller	1 year	Failure
	Head light assembly	1 year	Failure
	Battery pack	1 year	Failure
Outer parts	Recharger unit	3 month	Failure
	Front light shed	3 month	Fracture(exclude scratch)
	Meter shed	3 month	Fracture(excluding)
	Head front decoration board	3 month	Fracture(excluding)
	Head rear decoration board	3 month	Fracture(excluding)
	Rear fender	3 month	Fracture(excluding)

NON-GUARANTEE POLICIES

- 1.Unauthorized repair,abuse,impact,negligence, incident, modification, improper use, obliterate sticker & anti-fake sign, etc, all above actions lead to guarantees fall out of scope.
- 2.Failing to observe "WARNING" " CAUTIONS" operation principles
- 3.Out of warranty period of time
- 4.Damages by force majeure
- 5.Troubles falling out of list of trouble table for <Electric Scooter troubles list>
- 6.Led by personal factors <Electric Scooter troubles list>
- 7.Led by personal factors(include but not limited to water entry,tire-piercing,impact, scratching,damages under normal use.
8. If the products are intended for use of commercial activities.

TROUBLES LIST FOR ELECTRIC SCOOTER

Description	Troubles phenomenon
Electric scooter	Motor fails under normal riding Controller fails under normal riding Recharger fails under normal riding Battery fails under normal riding Deform, break under normal riding