

# USER MANUAL

## MAVERICK

### GK004E

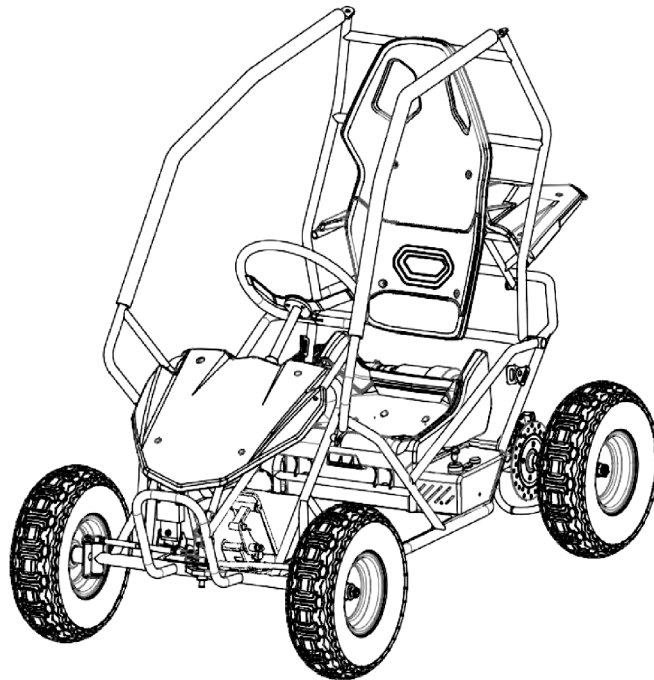

Warning: 1. Before using the product, please read the instructions carefully and learn about relevant local laws and regulations!

2. The battery needs to be fully charged for the first time for 12 to 14 hours, and the subsequent charging time is about 8 to 10 hours.

Please do not overcharge. Overcharging will shorten the service life of the battery and the charger.

When driving a go-kart, beginners should choose speed gear with adults, and then pull out the key to prevent children from adjusting gear privately, causing a safety accident.

## CONTENTS

Safety and Warnings .....	1
Before You Start .....	5
Assembly .....	6
Hardware Maintenance and Service .....	9
Before You Ride .....	10
Repair and Service .....	11
Troubleshooting .....	12
Explosive View .....	13

### Safety and Warnings

**Warning:** Drive electric go-kart carefully to prevent accidents - in certain situations, some functions of a go-kart may fail even if it is not due to product quality.No matter how careful we are and all the safety precautions we take, we may lose control of our vehicles.Risks are unavoidable. Drive carefully!

This manual contains a number of warnings and cautions for the consequences of failure to inspect, maintain or properly use electric go-kart.Since any event may result in serious injury or death, we do not repeat the statement of possible serious injury or death.

Understand and learn local laws and regulations to verify the legality of your use of this product.

#### Drive properly and safeguard procedures

When driving, you must wear necessary protective equipment such as:

- \* wear a good quality helmet (with a safety chin brace), and long hair must be pulled up before the helmet is worn.
- \* wear elbow and knee pads.
- \* wear long sleeves and pants.
- \* wear gloves.
- \* wear sneakers, don't go barefoot, wear sandals or slippers to drive, and make sure the LACES are fastened to keep them out of the wheels and drive system.

#### Driving tips

1. Before driving an electric go-kart, please study this manual carefully and understand the relevant driving knowledge.Minors must drive electric go-kart under adult supervision.
2. This manual contains extremely important information.Please read and learn the information carefully.Make sure you know all warning, caution items, instructions and safety warnings before using this product.To better guarantee your safety while driving an electric

go-kart. High Per Corporation Ltd. recommends you to review and review regularly.

Keep all the information in this manual in mind. Check and maintain your electric go-karts regularly to ensure their safety.

3. This product is suitable for people over 8 years old (including 8 years old) who weigh less than 70kg. Any driver who is not comfortable driving an electric go-kart should not be forced to do so. Minors must drive electric go-kart under the supervision of their parents. Parents should decide whether to let their children drive electric go-karting or not based on their knowledge of driving, their ability to learn relevant laws and regulations, and their proficiency in driving skills.

4. Special reminder: please do not touch the motor and brake of the electric go-kart while using this product or shortly after using it, because the motor and brake will generate a lot of heat when running at high speed, and there will be a risk of burns.

5. When electric go-kart is not in use, place it away from children. Keep in mind that it is only suitable for people over the age of 8 who have good driving knowledge and good driving skills.

6. This product has high speed and low speed, with a top speed of 25km/h and a top speed of 15km/h. Please make sure you are legal, safe and appropriate in the driving environment, adjust the gear.

#### **Field driving and conditions**

This product is a non-road product. Please understand relevant laws and regulations to guarantee the legality of the place where you drive the electric go-kart.

1. Always be careful while driving! Beware of obstacles that may jam the wheels, or force you to swerve or get out of control. Also, avoid pedestrians and other vehicles (such as skaters, skateboards, bicycles, etc.), as well as children or animals that may enter your route.

2. Make sure you turn on the power switch after you are ready to drive in a legal, safe and suitable outdoor environment.

3. Please do not use this electric go-kart for performance, competition or dangerous action. This product cannot tolerate jumping and any other type of abuse.

4. When driving, please do not let go of one hand or completely, please always hold the steering wheel with both hands!

5. Two or more people are not allowed to drive an electric go-kart at the same time!  
Or drag anyone or anything!

6. Please do not drive electric go-kart near the entrance of the building, the pond or the swimming pool.
7. Do not let your fingers and other parts of your body touch the chain, motor, wheel and all other moving parts!
8. Don't use your phone or headphones while driving!
9. Stay away from pedestrians and other vehicles while driving!
10. When driving, please try to avoid the flooded road section, so as to prevent water from the motor and other electronic components, short circuit fire occurred during charging, or cause other hidden dangers!
11. When driving, drive on flat, dry ground, or flat ground without objects such as sand, leaves, rocks, or gravel. Because water, mud, ice, bumps, and uneven ground can all cause vehicles to lose control. In addition, when going downhill, please avoid driving too fast, so as to avoid accidents caused by vehicles losing control.
12. This product is not equipped with lamps, please do not drive in the night, rainy days or poor visibility.
13. Do not drive indoors or on other surfaces that may be out of control, such as carpets or slippery surfaces.
14. The product shall be inspected and maintained periodically after being used for a certain period of time to ensure that all parts and warnings of the product are intact.
15. Before each drive, make sure all the fasteners (such as bolts and nuts) for the electric go-kart are in place. Steering wheel, sprocket, chain, warning label, etc., should meet the standard when the product leaves the factory.
16. People who are not suitable for this product include: people with heart disease, pregnant women, diseases, unfitness, or people who have just had surgery. In this kind of people, there is a big gap between psychological or physiological conditions and normal people. These gaps can easily lead to accidents.
17. After unpacking, the electric go-kart must be charged before use and can reach 12 to 14 hours. Don't overcharge. Overcharging shortens the life of the battery and charger.
18. Prohibit the alteration and modification of vehicles and parts. In case of risk accident caused by changing or refitting vehicles and parts, the party shall bear its own responsibility.
19. Before driving an electric go-kart, check the following.
  - \* ensure that the brake system functions properly.
  - \* ensure all parts are installed in place, consistent with delivery.
  - \* the original parts of the company shall be used for the maintenance and repair of relevant parts.It shall be installed and operated by the dealer or other personnel with relevant skills.

---

### **USE THE CHARGER**

1. Chargers should be checked frequently to prevent damage to wiring, plugs, shells and other accessories. If any damage is found, it shall immediately stop using the charger to charge the car until the charger is repaired or replaced.
2. This product can only use the charger provided by our company!
3. Chargers are not toys and should be operated by adults!
4. Don't use a charger near flammable objects or liquids!
5. When idle, disconnect the power supply and pull out the charging plug from the electric go-kart!
6. Charging time should be within the recommended time, and do not time out!
7. Before wiping and cleaning, please remember to disconnect the electric car charger!

Failure to comply with the above warnings can pose serious safety risks.  
Drive carefully and always wear protective gear!

## BEFORE YOU START

Warning: after unpacking the packing boxes, please check whether the attachments in the packing boxes are consistent with the packing list. Before assembling the electric go-kart, please confirm whether the power switch is in the "off" state. Otherwise, please turn off the power switch and assemble the go-kart again!

1. General 25 minutes can be assembled complete (excluding initial charge time).
2. Initial charging time is about 12 to 14 hours.

## Estimated Time for Assembly

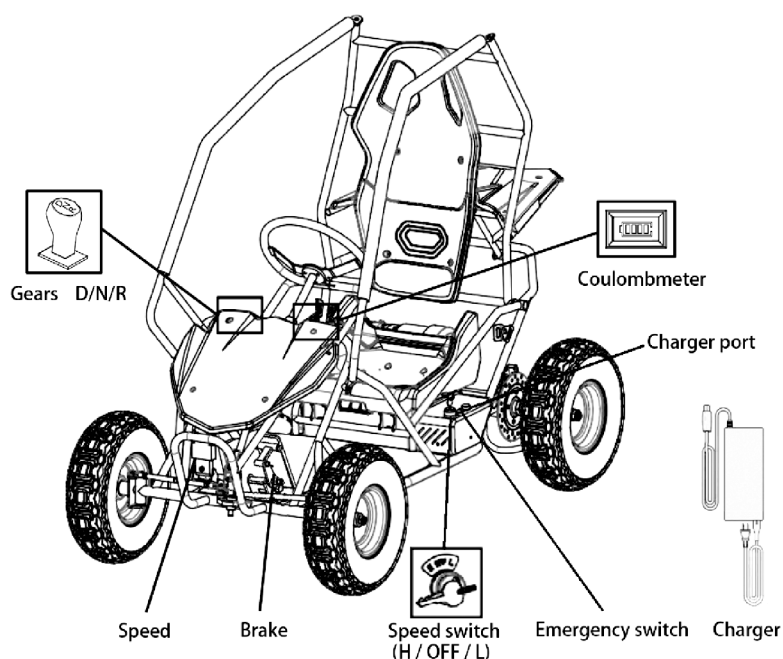

## WARNING

When driving a go-kart, beginners should choose speed gear with adults, and then pull out the key to prevent children from adjusting gear privately, causing a safety accident.

Emergency switch is an important installation device for vehicles. When the emergency switch is in the "ON" gear, the power supply of the whole vehicle is connected; when the emergency switch is in the "OFF" gear, the power supply of the whole vehicle is disconnected.

When the guardian sets the speed gear and takes out the key, after the user drives, the emergency switch can cut off the power supply of the whole vehicle, so that the whole vehicle is in a safe state.





1pc 13mm open spanner, 1pc 17mm open spanner (include)  
1pc 19mm open spanner, 1pc 22mm open spanner (included)



2pcs 5mm socket hexagon spanners, 1pc 6mm socket hexagon spanner (included)

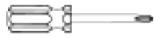

1 pc Philips screw driver (included)

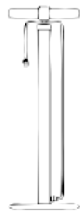

1pc pump (not included)

Warning: Do not use chargers not supplied by High Per Corporation Ltd. Because this kind of electric go-kart car is produced according to the special design specification of High Per Corporation Ltd. it is forbidden to make any modification. Changing the original parts is not compatible with the original design and will cause risk accidents.

## Assembly

Required tools: two sets of 5mm Allen wrench, one set of 6mm Allen wrench, one set of 13mm open spanner and one set of 17mm open spanner



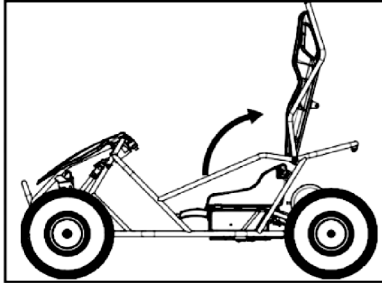

1. Lift the back of the chair by hand, perpendicular to the ground.

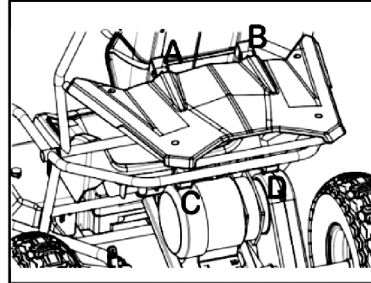

2. Secure the fixed holes A, B, C, D of the backrest support to the frame. Align the pins, then insert the mounting bolts and the nuts in turn. Then tighten with two 5mm Allen wrenches.

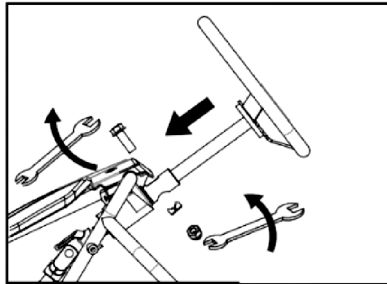

2. Insert the steering wheel into the positioning sleeve of the steering wheel, align the limit hole, then insert the clamp and nut in the direction of the bolt belt, and then lock the fixed bolt and nut with the 13mm open spanner and 17mm open spanner.

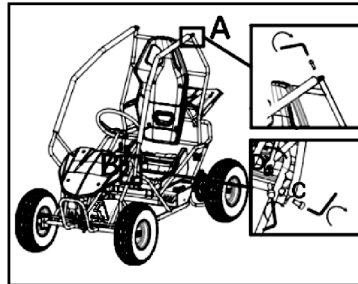

3. Align the fixed hole at A and take the bolt; Put the fixed hole at B. Align, with bolt at C; Put the bolt and the anti-loose nut on place D, and then tighten the bolt nut with a 6mm Allen wrench and a 13mm open end wrench. Then screw down the other two bolts with a 6mm Allen wrench.

## Tire inflation

Need tools: 1pc PUMP

1. Although the tire has good air tightness, there will always be a small amount of gas lost slowly. Therefore, when the tire has insufficient air pressure, the tire should be inflated.
2. Recommended air pressure of the front wheel: 30Psi, and recommended air pressure of the rear wheel: 30Psi

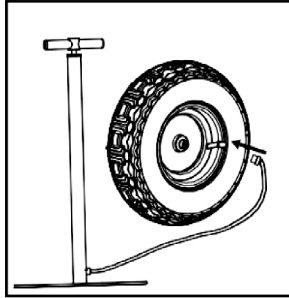

Tire inflation: First unscrew the valve cover of the tire, and then align the valve of the pump on the tire valve, bite and press well, and then inflate the tire until the air pressure reaches the recommended value of 30Psi.

Warning: it is important to check and maintain the tire regularly to ensure that the tire pressure is calibrated. Because tire pressure directly affects the safety and performance of electric go-karting vehicles. Don't overinflate. Excessive tire pressure can damage tires and wheels. Lack of tire pressure will result in less distance and lower maximum speed!

## Charge the battery

Warning: before riding a go-kart, make sure the battery is fully charged and do not overcharge!

Need part: Charger

1. Initial battery charging time: 12 to 14 hours.
2. Subsequent charging time of each battery: about 8 to 10 hours.
3. In order to maintain superior performance, the kart needs to be charged at least once a month when it is idle.

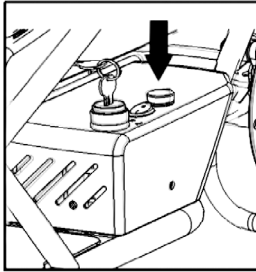

### Charging Mode A

1. Make sure the power switch is "OFF" before inserting the charger. Plug the charger into the charging port on the left cover.

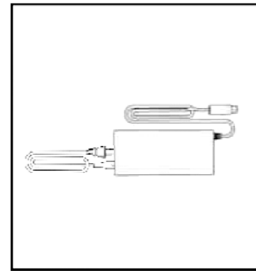

2. The charger plug is connected the 110V or 220V AC power supply. The charger light should be on. The red light indicates that the battery is charging, and the green indicates that it is full.

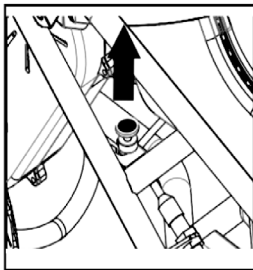

### Charging Mode B

1. The seat pad on the right side of the seat pad is pulled up to open the seat pad.

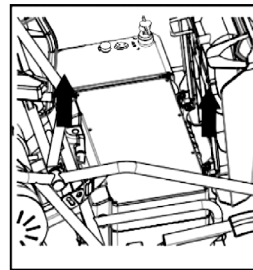

2. Unplug the connection between the battery box and the electric device, and then hold the handle and block on the battery box, and take out the battery box.

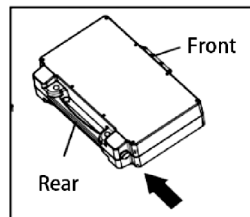

3. The battery box can be charged separately.

Warning: do not use electric go-karting cars for the first time unless the battery has been charged for 12 to 14 hours! Failure to follow these instructions may damage the performance of the electric go-kart and render the electric go-kart outside the scope of the warranty. Charging must be done in a safe environment.

Note: the charger has a light indicating the charging status. Refer to the color red and green of the indicator light on the charger to judge the "charging" and "full" status. It is normal for the charger to get hot during charging. Don't worry.

Note: the battery must be charged at least once a month when the electric go-kart is idle. Failure to do so could result in poor battery charging.

## Hardware Maintenance and Service

### 1. The brake

Please check whether the brake function is normal: a. Make sure that the rear wheel will stop rotating when the brake pedal is applied tightly. B. Make sure the power supply is disconnected and the motor does not work when both the brake and throttle are in use. C. Make sure that wheels should be flexible and free of lag when there is no brake.

### Frame and steering wheel

Check the frame and steering wheel for cracks or loose joints. It is necessary to develop the habit of maintaining electric go-kart on a regular basis.

### 3. The tire

Check the air pressure of the front and rear wheels regularly to see if they meet the standard air pressure and check if the wheels are over-worn.

### Wear protective gear

Always wear quality-assured safety helmets, elbow and knee pads, shoes, and other protective equipment, while wearing sneakers, never bare feet, sandals or slippers to drive, and make sure the LACES are fastened and kept outside the wheels and drive system.

### 5. The battery

Whenever an electric go-kart is not in use, be sure to turn off the power switch. Do not store electric go-kart in cold or frosty places! Low temperatures can cause the battery's performance to deteriorate or permanently fail.

## Before you ride

Always check the following before driving:

### Safety equipment

Always wear appropriate protective equipment, such as

1. Quality assured helmet chin strap (with security), long hair must wear a helmet again after the hair is up.
2. Elbow and knee pads.
3. Long sleeved shirts and pants.
4. Gloves.
5. Sneakers.

#### The brake

Please check whether the brake function is normal;When the brake pedal is pressed, the rear wheels stop spinning.When the brake pedal and the accelerator pedal are used together, the power supply should be broken and the motor does not work.And make sure that when there is no brake, the wheels should turn flexibly and without stuck.Never drive an electric go-kart if the brakes fail.

#### The accelerator pedal

When the power switch is "on" and the accelerator pedal is pressed, the motor starts working and drives the electric go-kart forward.Before stepping on the gas pedal, make sure you're in the open, safe zone.When driving an electric go-kart, keep your body balanced, fasten your seat belt, and hold the steering wheel with both hands.

#### tire

Please check whether the tire pressure is up to the standard pressure. If not, please inflate the tire.Check the tires for severe wear/aging. Replace the tires if necessary.

#### Frame, steering wheel

Before driving, please carefully check the frame, steering wheel of the electric go-kart.Check for cracks, damaged or loose parts;If there is any abnormality, please repair or replace it in time.

#### The battery

When not using electric go-kart, make sure the power switch is "off".Do not store electric go-kart in cold or frosty places!Low temperatures can cause battery performance to degrade or permanently fail.

#### Meter (electricity display)

Before starting the go-kart, check the meter to see if the power is sufficient.If not, please charge the battery.(each grid in the meter represents 25% power, and red frame is displayed when the power is less than 25%.)

#### Electric door lock (high and low speed switch)

When starting a go-kart, you should insert the key into the electric door lock, and then choose proper gear to start (L is low speed, H is high speed, OFF is stop, each gear can pull out the key).When driving a go-kart, beginners should choose low speed gear with adults, and then pull out the key to prevent children from adjusting their gear privately, causing a safety accident.Only when you are proficient in driving can you choose high speed gear in a safe and appropriate environment.When the go-kart is stopped, the key should be turned OFF, and the key should be pulled out to prevent children from starting the go-kart and causing safety accidents.

Warning: make sure you are in a safe, open area before starting your electric go-kart. Before you grab the steering wheel with both hands, fasten your seat belt, and sit on the electric go-kart, do not reverse the electric door lock and start the electric go-kart.

If you do not follow the above instructions, you may damage the electric go-kart. Damage for this reason is not covered under warranty

## Safety Belt

### Use of Seat Belt

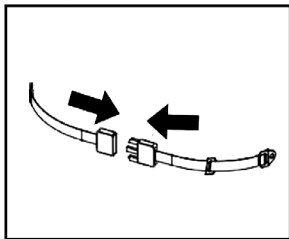

1. Sit on the seat and pull out the seat belt with one hand. Hold the buckle with the other hand and fasten the buckle piece to make sure that the seat belt is firmly fastened to the body.

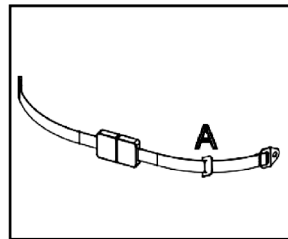

2. If you feel the seat belt is too loose or too tight, you can adjust it through the buckle at A.

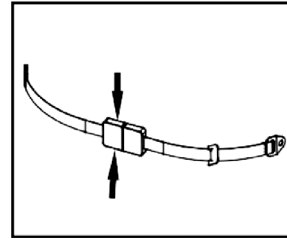

3. Unfasten your seat belt. Hold the clip with one hand, press the button in the middle of the clip with the other, pull out the button, and then put the safety belt in the collecting position.

Warning: check the safety belt before driving to make sure the safety belt is in good condition before starting the go-kart.

## Repair and maintenance

Warning: make sure the power switch is "off" before performing any maintenance.

### Brake adjustment

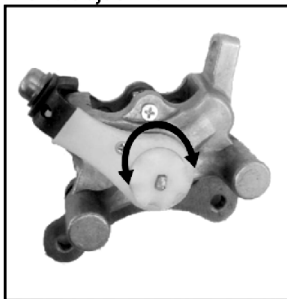

1. If the brake is too tight or loose, you can generally adjust the tightness of the brake line clockwise (tight) or counterclockwise (loose) by adjusting the adjusting nut on the disc brake. (as shown on the left)
2. Generally, no adjustment is made. The brake has been adjusted to a proper position before leaving the factory.
3. If the brake shoe wear is found and the braking effect is not good, contact the dealer or professional maintenance technician for adjustment, so that the braking effect can reach the best.

Warning: if not operated properly, brake may be locked or rear wheel side slip. Try to avoid rear wheel side slip as this may cause you to lose control of the electric go-kart and damage the rear wheels. To familiarize yourself with the functions and characteristics of the brakes, practice braking in open areas without obstacles and achieve free parking.



## Chain and rear wheel replacement

Need tools : cross screw driver, 22mm open end wrench

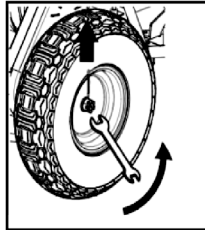

1.Pull out the opening pin on the flange nut first, then use the 22 mm open spanner to release the locking mother of the counterclockwise rear wheel, and then remove the rear wheel.

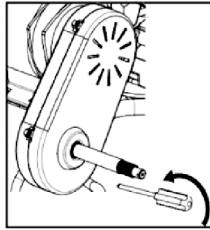

2.Loosen the 4 screws on the cover with the cross screwdriver counterclockwise.

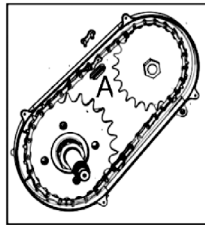

4.Remove the link at A, and then remove the whole chain.

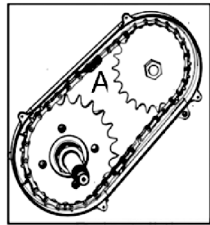

5.Reinstall the chain in accordance with 4 steps to ensure that the link of the chain is firmly installed.

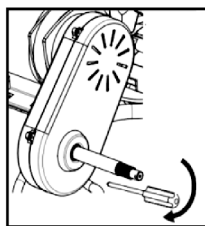

6.Tighten the 4 screws on the cover clockwise with the cross screwdriver.

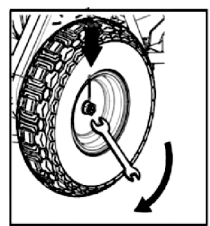

7.Install the changed rear wheel onto the rear axle, then screw the rear wheel lock nut clockwise with a 22mm open spanner, and then insert the split pin into the flange nut.

## Front wheel replacement

Need tools : 19mm open end wrench

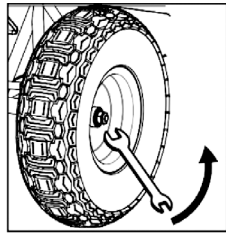

1.Remove the front wheel by turning counterclockwise with a 19mm open wrench.

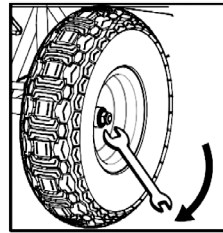

2.Turn the front wheel clockwise with a 19mm open wrench.

Make sure all accessories are installed in the correct location when you restore the installation. (Please refer to the method of rear wheel dismounting)

## Battery maintenance and processing

Please don't put the battery in degrees Celsius above 25 °C below 0 °C or C environment

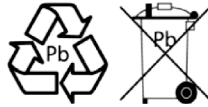

This electric go-kart USES sealed lead-acid batteries, which must be recycled according to local laws and regulations. Please carefully read and understand the following battery treatment instructions.

Waste treatment: this product contains sealed lead-acid battery; They should be treated or recycled in a scientific way, with an emphasis on environmental safety. Please do not treat the waste battery as household garbage, and do not throw them into the fire, which will lead to the leakage of dangerous materials or battery explosion. In most areas, it is forbidden to burn, bury or discard sealed lead-acid batteries into household waste. Please send the discarded batteries to the national or state-authorized lead-acid battery recycling station or contact the local battery dealer.

**Warning:** do not mix old and new batteries. Do not mix basic, standard (carbon-zinc), or rechargeable (nickel-cadmium) batteries. Don't put the battery in more than 25 °C or below 0 °C environment.

### Charger

Please use the car charger. If the charger is damaged, please stop using the charger to charge the electric go-kart. Please purchase original charger for replacement.

### Wheel

Wear and tear on wheels and drive system accessories is inevitable over time. The user is obliged to check the wear and tear of the wheel and drive system parts regularly and adjust and replace them according to the related requirements.

**Warning:** after disposing of used batteries, wash your hands with the prescribed detergent

## Troubleshooting guide

Problem	Possible cause	Solution
The electric go-kart won't start	The battery might run out of power.	Recharge the battery. The initial charging time should be 12 to 14 hours, and the subsequent charging time is about 8 to 10 hours.
	Joints of cables and connections may be loose and have poor contact	Disassemble the electrical cover and check whether the power connection and controller connection are loose and come off. If yes, please plug it again and test whether it starts normally.
Electric go-kart has short service time	The battery is not charged with electricity	1. Recharge the battery. The initial charging time should be 12 to 14 hours, and the subsequent charging time is about 8 to 10 hours. 2. Check whether the power plug of the charger is connected with the ac power supply.
	The battery could not charge more electricity	Replace the battery -- although you maintain it properly, the battery cannot be maintained indefinitely in a good condition; The service life of general battery is one to two years, the specific use time depends on the actual use of electric go-kart.
	Improper brake adjustment	Refer to the brake adjustment instructions on P8.

The electric go-kart stopped working suddenly

Controller trip

1. When the motor is overloaded, the controller can automatically trip off the power supply and start the protection function.
2. Excessive overloading (steep slope or heavy driver) will lead to excessive current and lead to controller over-current protection startup and disconnection of the circuit. When (a go-kart) suddenly occurs Stop, wait for a moment, after about 10 seconds the controller restores itself, and then switch on the circuit.

---

When the electric go-kart drives, the chain sounds loudly

The chain oil is dry

The chain track is no longer on the specified track (the chain and the rear sprocket are not on the same plane).

Please lubricate the chain

Please reset the chain. Refer to the adjustment instructions for the chain on P9. Or ask professional technical personnel to help adjust maintenance.

Electric go-kart is slow

The electric go-kart is overloaded

Make sure the electric go-kart is not overloaded.

Do not climb steep slopes or use scooters to drag cargo. Overloading should be avoided.

Overloading will cause premature aging of the batteries and electronic components of electric karting vehicles.

Bad driving conditions

Drive only on firm, flat, clean, dry ground such as sidewalk, level ground.

Battery under voltage

Please check if the battery is fully charged.

## Explosive View

No.	Parts	No.	Parts
1	Steering wheel	31	Safety belt
2	Directional intermediate bar	32	Rear brake
3	Directional column axis (up)	33	Rear wheel
4	Cardan joint	34	Rear hub
5	Directional column axis (down)	35	Brake Disc
6	Steering kunckle ( left )	36	Flange
7	Steering kunckle ( right )	37	Grease seal
8	Drag link	38	Bearing
9	Front hub	39	Rear axle shaft
10	Front wheel	40	Chain plate
11	Connecting base	41	Chain
12	Accelerator pedal	42	Joint lever ( left )
13	Brake pedal	43	Joint lever ( right )
14	The power switch	44	Backrest
15	Frame	45	Backrest support
16	Gear switch	46	Front plastic cover
17	Meter	47	Pedal plate
18	Rear frame	48	Stop hand shank
19	Rear plastic cover	49	Stop lamo switch
20	Seat	50	Seat lock cable
21	Seat support	51	Sponge
22	Controller	52	Power switch
23	Line cover		
24	Speed switch		
25	Charger port		
26	Brake line		
27	Battery		
28	Battery box		
29	Motor		
30	Chain cover		

