

212CC GO-Kart

OWNER'S MANUAL



Model:FR200GK; GK014

RECOMMENDED AGE 16+

PROVINCIAL / MUNICIPAL GOVERNMENTS HAVE DIFFERENT REGULATIONS PERTAINING TO OWNING AND OPERATING AN OFF-ROAD VEHICLE, LEARN THE REGULATIONS IN YOUR AREA.

To the owner

Congratulations on your purchase of a Funrun Go Kart. This owners/operators' manual will provide you information regarding safe operation, operational instructions, maintenance and care. Fully understanding this manual and following all of the instructions herein will provide the knowledge needed to have safe and enjoyable Go Kart operation.

Safety & Notice to parents

The recommended age for operating this Go Kart is 16+. Not all teenagers have the strength, size, skill, and judgment needed to operate this vehicle safely.

THIS GO KART IS NOT A TOY AND COULD BE HAZARDOUS TO OPERATE. A Go Kart handles differently from other vehicles including motorcycles and cars. A collision or rollover can occur quickly, even during routine maneuvers such as turning, driving on hills and over obstacles.

Reading the owner's operator's Manual

It is important this manual is read from cover to cover carefully by the Go Kart owner and all operators. Parents should review the manual carefully with their children. Never allow anyone to operate the Go Kart without first reading and understanding the owners/operator's manual.

This owners/ operators' manual should be a permanent part of the Go Kart and should remain with the vehicle at all times. The manual should also remain with the vehicle if sold.

To emphasize special important information in the manual, please note the following:



This is the alert symbol. The symbol means **ATTENTION!** , **BECOME ALERT!**

To emphasize important safety information, the word **WARNING**, with the alert symbol, has special meaning:



Indicates a potential hazard that could result in **SEVERE INJURY** or **DEATH** to the operator, bystander or person repairing the go-kart.

To emphasize important information, the word **CAUTION** has special meaning:

CAUTION:

Indicates special precautions that must be taken to avoid damage to the Go Kart.

To emphasize important information, the word **NOTE** has special meaning:

NOTE:

Indicates key information to make procedures easier or clearer to understand.

 WARNING OR CAUTION	
The first part will identify a POTENTIAL HAZARD .	
The second part will describe WHAT COULD HAPPEN if the warning or caution is ignored.	
The third part will describe HOW TO AVOID THE HAZARD .	

Funrun is concerned about the environment and believes in conserving and protecting all-natural resources. For this reason, owners should recycle, trade in, or dispose as appropriate, oil and tires.

This manual is based on the latest product information available at the time of publication. Funrun has a policy of continually improving its products. Due to improvements, or other changes, there may be some discrepancies. we reserve the right to make product changes at any time, without notice and without incurring any obligation to make the same or similar changes to vehicles previously built or sold.

WARNING

operating, servicing and maintaining a passenger vehicle or off-road vehicle can expose you to chemicals including engine exhaust, carbon monoxide, phthalates, and lead, which are known to the state of California to cause cancer and birth defects or other reproductive harm. To minimize exposure, avoid breathing exhaust, do not idle the engine except as necessary, service your vehicle in a well ventilated area and wear gloves or wash your hands frequently when servicing

Your vehicle. For more information go to www.P65warnings.ca.gov/-passenger-vehicle

IMPORTANT LABELS

LOCATION

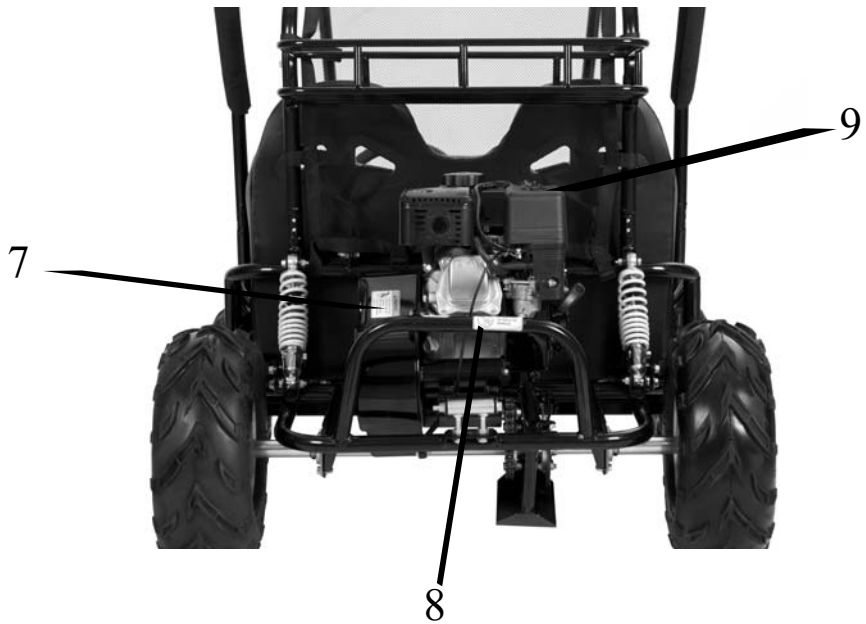
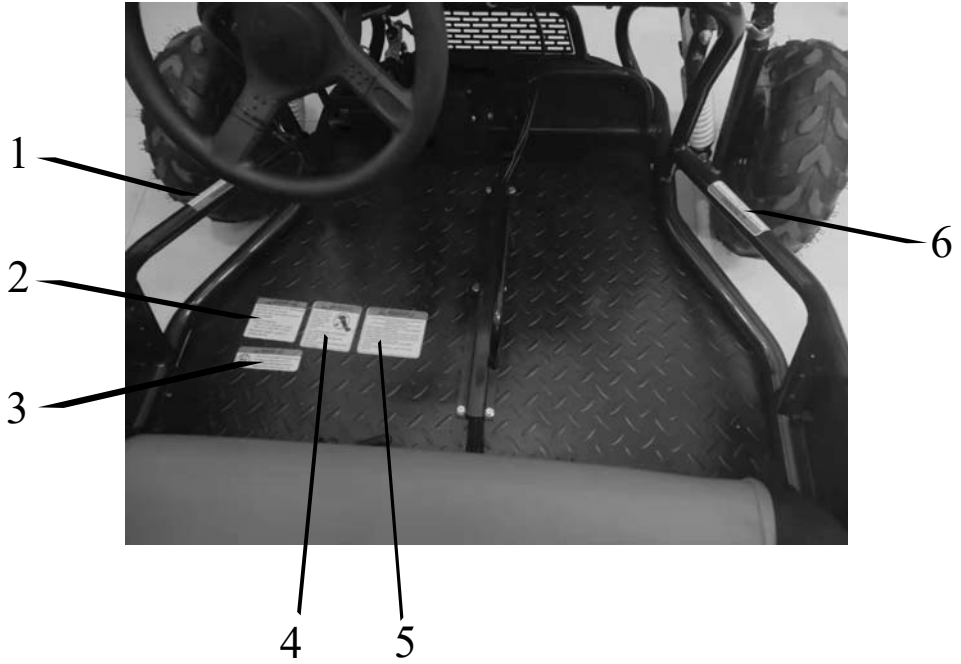

IMPORTANT LABELS

1



2



3



4



5



6



7



8



9

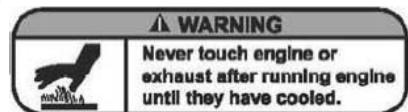

SAFETY

1. Always read and understand the owner's/operator's manual and warnings before starting the Go Kart for the first time
2. This Go Kart should only be assembled by someone who has the knowledge, ability and skills to read and understand mechanical instructions.
3. Use caution when providing maintenance on this Go Kart. Make sure engine is turned off and all components are cool. Never attempt to make any adjustments while engine is running.
4. Do not modify this Go Kart in any way, modifications could make the Go-Kart unsafe and/or in violation of Federal and State laws.
5. This Go Kart is recommended for riders 16 and older.
6. Always wear a certified DOT motorcycle or ATV helmet that fits properly.
7. This Go Kart is designed for one operator and one passengers.
8. Always wear seat belt provided. Make sure seat belts fit properly before starting the Go Kart.
9. Never operate this Go Kart on paved surfaces and/or public roads. Pavement may cause the Go Kart to become unstable.
10. The head bar in back of the operator is not intended to provide rollover protection. Before each use, make sure all tubes are securely in place and bolts are tight.
11. Never operate Go Kart with long hair, loose jewelry or loose clothing that could get caught in moving parts.
12. Always go slow on unfamiliar terrain. Be alert to changing terrain conditions when operating the Go Kart.
13. Never take drugs or alcohol before or during operation of this Go Kart.
14. Never attempt jumps or any other type of stunts while operating this Go Kart.
15. Always follow the pre-ride inspection procedures and maintenance procedures located in this manual before use.
16. Always go slow on terrain that is not familiar, be alert, an obstacle could come up unexpectedly.
17. Always keep hands, arms, legs and feet inside the Go Kart at all times.
18. Never operate Go Kart in water that is deeper than 2 inches. Do not operate in fast flowing water. Water can affect braking performance of the Go Kart. Check braking performance after exposure to water, it may be necessary to apply the brakes allowing friction to dry out the pads.
19. Do not attempt to fill the Go-Kart with gasoline while the engine is running or the engine is hot.

DESCRIPTIONS AND PART LOCATIONS

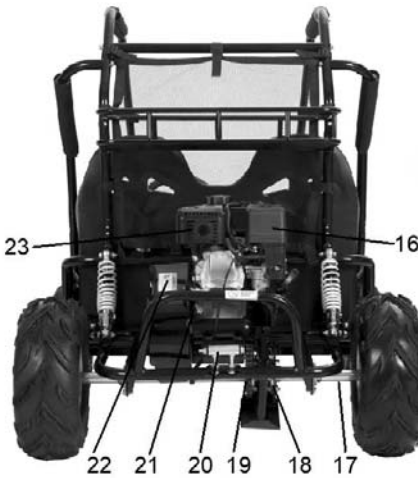
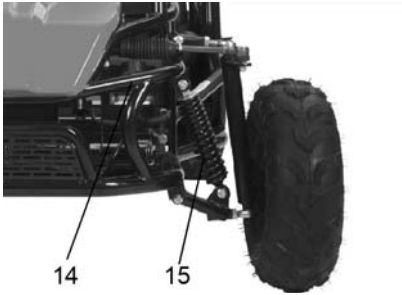

1. Front Wheel
2. Front Face Mask with Ignition Switch
3. Steering Wheel
4. Protective Leather Sheath
5. Rear Protective Net
6. Luggage Rack
7. Seat
8. Engine
9. Rear Wheel
10. Rear Shock Absorption
11. Seat Belts
12. Brake Pedal
13. Gas Pedal
14. Brake Fluid Reservoir
15. Front Shock Absorption
16. Air Filter Housing
17. Rear Axle
18. Rear Brake Caliper
19. Drive Chain
20. Chain Adjuster
21. Oil Fill Plug/Dipstick
22. Chain, Torque Converter and Brake Caliper Cover
23. Muffler
24. Fuel Tank Cap
25. Fuel Tank
26. Starter Recoil Cord

DESCRIPTION AND PART FUNCTIONS



starter recoil cord(1) : Before driving a go kart, you must pull the starter recoil cord hard to start the engine.

Note: The ignition switch must be placed in the ON position when you pull the Pull start cord.

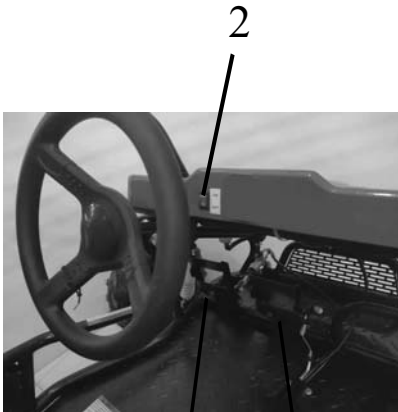

Ignition switch(2) : when the ignition switch is placed in the ON position the engine can start.

when the ignition switch is placed in the OFF position the engine will stop.

Brake Pedal(3) : Depressing the brake pedal will stop the Go Kart.

Note: Always check brakes before operation

Gas Pedal (4): Depressing gas pedal will increase engine RPMs causing Go Kart to move forward.

DESCRIPTION AND PART FUNCTIONS

Fuel Cap



Fuel Tank Cap(1) :

To open fuel tank cap, Turn cap counter clockwise to remove. To reinstall cap, turn cap clockwise until snug. Make sure cap is seated properly.

Oil Fill Plug / Dip Stick

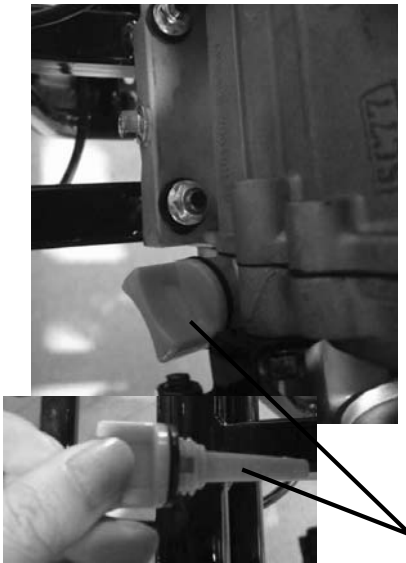

oil Fill plug/Dipstick(2)

To open oil fill plug/Dipstick, turn cap counter clockwise to remove. To re-install cap, turn cap clockwise until snug. Make sure cap is seated properly.

2

DESCRIPTION AND PART FUNCTIONS

SEAT ADJUSTMENT

⚠ WARNING

Failure to have the seat locked in position could be hazardous.

The seat coming loose could cause the operator to lose control.

Never operate the Go Kart without the seat locked in place.

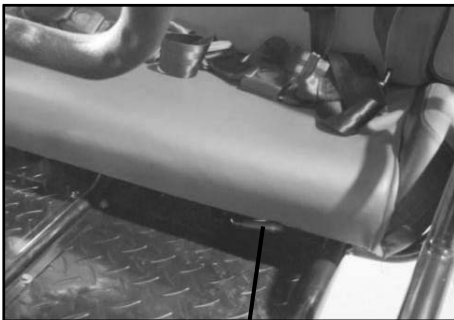

Seat adjustment (1)

The seat latch is located under the driver side seat. To access, look under the front of the driver side seat. Pull the seat latch down to move the seat forward or backward. Before operating the Go Kart make sure the seats are bolted in properly and that the seat latch is locked in place in desired position.

FUEL AND OIL

FUEL

Never use leaded gasoline in this product. Leaded fuel could affect the engine's emissions and damage the engine.

Go Kart requires clean unleaded regular gasoline with minimum octane rating of 87 or higher.

Gasoline/ Ethanol blends

A blend of unleaded gasoline with Ethanol, also known as GASOHOL, at or below 10% E10 can be used in your Go Kart. Ethanol greater than 10% can damage your engine and will void your warranty.

Gasoline/Methanol Blends

A blend of gasoline with Methanol of 5% or less can be used in your Go Kart. Do not use gasoline, under any circumstances, containing more than 5% Methanol, doing so will damage your engine and will void the warranty.

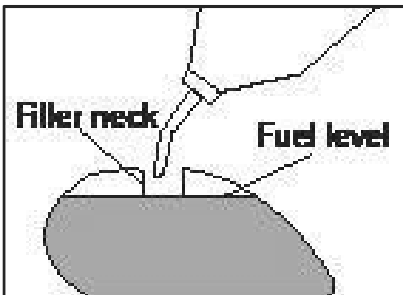

⚠ WARNING

overfilling the fuel tank can cause the fuel to expand which can cause overflow due to the heat from the engine or sun. spilled fuel can catch fire.

Never fill the fuel tank above the bottom edge of the filler neck.

⚠ WARNING

Fuel and fuel vapor are highly flammable and toxic. You can be burned or poisoned while refueling.

Before refueling make sure to follow the procedures listed:

1. shut off engine, Make sure there are no flames, sparks or heat sources close by.
2. Make sure engine has cooled
3. Refuel only outdoors in a well ventilated area.
4. Do not smoke while refueling.
5. wipe up any spills immediately.
6. Avoid breathing any fuel vapors.
7. Keep children and pets away.

ENGINE OIL

The recommended oil for this Go Kart is SAE10w-30 motor oil, if this oil is not available, any of the oil on the chart below will work. Note the temperature requirements for each of the oils.

quantity of oil - 0.47qt.(0.45L) .

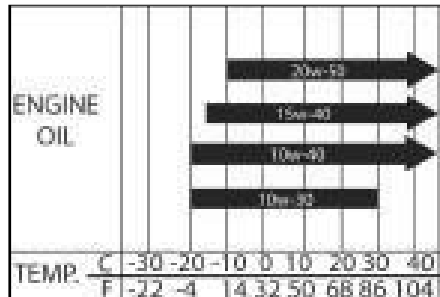

PRE-RIDE INSPECTION

Inspecting and checking the condition of the Go Kart before each ride is important. Following the pre-ride check list will help insure the you do not have mechanical problems which could result in injury or becoming stranded. Make sure the Go Kart is in good operating condition before each ride.

⚠ WARNING

Failing to inspect and maintain your Go Kart could be hazardous.

Not following the pre. ride inspection procedures could result in losing control of the Go Kart resulting in an accident or damage to the Go Kart.

Always perform a Pre. ride inspection before operating.

⚠ WARNING

Performing maintenance and checks while the engine is running could be hazardous.

You could be severely injured by moving parts or hot surfaces.

Never perform maintenance or check procedures while the engine is running with the exception of checking the ignition switch or throttle.

WHAT TO CHECK	CHECK FOR
steering	<ul style="list-style-type: none"> ◦ smoothness ◦ No restriction of movement
Brakes	<ul style="list-style-type: none"> ◦ Correct fluid level ◦ Inspect hoses for leaks ◦ Inspect brake pads for wear.
Tires	<ul style="list-style-type: none"> ◦ Proper tire pressure ◦ Proper tread depth ◦ Rubber has no cracks
Fuel Tank	<ul style="list-style-type: none"> ◦ Enough fuel for the ride ◦ Fuel cap secure ◦ Hoses have no signs of cracks or leaks
Throttle Pedal	<ul style="list-style-type: none"> ◦ Pedal snaps back to idle when released ◦ operates freely
Engine Ignition switch	<ul style="list-style-type: none"> ◦ switch shuts off engine when activated.
Engine oil	<ul style="list-style-type: none"> ◦ Correct oil level
Drive Chain	<ul style="list-style-type: none"> ◦ Proper tension ◦ Lubricated ◦ No excessive wear or damage
General Condition	<ul style="list-style-type: none"> ◦ All nuts and bolts tight ◦ No rattles from Engine or frame while running.

OPERATING THE GO KART



WARNING

Carrying more than one passenger on this Go Kart could be hazardous.

Carrying more than one passenger could cause loss of control resulting in severe injury or death to the operator and/or passengers.

This Go Kart is designed for one operator and one passenger. Never allow more than one passenger.



WARNING

operating this Go Kart in a irresponsible manner which includes jumping or other stunts could be hazardous.

Jumping or other stunts could result in loss of control of the Go Kart resulting in severe injury or death.

Never attempt stunts, such as jumping.



WARNING

operating a Go Kart on hills could be hazardous.

operating a Go Kart on a hill could result in rolling over while traversing, flipping over backwards while climbing, flipping over while descending, general loss of control of the Go Kart. Any of these accidents on a hill could result in severe injury or death.

Never operate a Go Kart on steep hills.



WARNING

operating this Go Kart on any public road or highway could be hazardous.

You could collide with another vehicle if you operate on public roads or highways resulting in severe injury or death.

Never operate on public roads or highways.

OPERATING THE GO KART

HELMET, EYE PROTECTION, PROTECTIVE CLOTHING

Always wear a DOT certified helmet (1) . A helmet helps protect against serious head injuries in the event of an accident. A helmet is the most important safety gear item you can wear. Consult with a motorcycle dealer for the correct size and type of helmet that is right for you.

Always wear eye protection when operating a Go Kart such as a face shield or goggles(2) . while operating a Go Kart you can be hit in the eyes by any of the following: dust, branches, rocks, debris from other operators, bugs, etc. Good eye protection as well as a helmet and protective operating gear should be mandatory when operating a Go Kart.

wear protective clothing: Long sleeve shirt(3) , Gloves(4) , Long pants (5) , over the ankle boots(6) . operating a Go Kart exposes the operator to many hazards, wearing protective clothing can help protect the operator from injury.

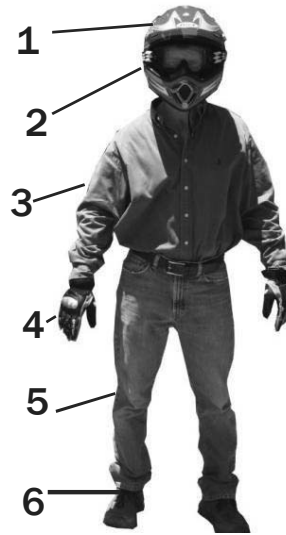

⚠ WARNING

operating a Go Kart without a helmet, eye protection, and protective clothing can be hazardous.

operating a Go Kart without a helmet increases the chance of severe head injury or death in the event of an accident.

operating a Go Kart without eye protection such as a face shield or goggles could result in severe injury in the event of an accident.

operating a Go Kart without protective clothing; closed toe shoes, long pants, gloves, long sleeve shirt could result in severe injury in the event of an accident.

Always wear a Helmet, eye protection, long pants, long sleeve shirt, over the ankle boots and gloves while operating a Go Kart.

OPERATING THE GO KART SEAT BELTS



WARNING

Riding in this go kart without the seat belt harness worn and attached properly for both the operator and passenger could be hazardous.

Riding the go kart without the seat belt harness worn by both the operator and passenger increases the chance of injury or death in the event of an accident

Never operate or allow a passenger to ride in the go kart without the seat belt harness worn and attached properly.



Never start the go kart without the operator and passenger wearing the seat belt harness in the appropriate manner.

To connect the seat belt harness properly sit in the seat and place arms through the shoulder straps(1) on the corresponding side of the harness. After shoulder strap is in place, buckle the lap belt(2) and tighten by pulling the loose ends(3) .

If there is no passenger in the passenger seat, make sure the passenger seat belt is latched together and secure.

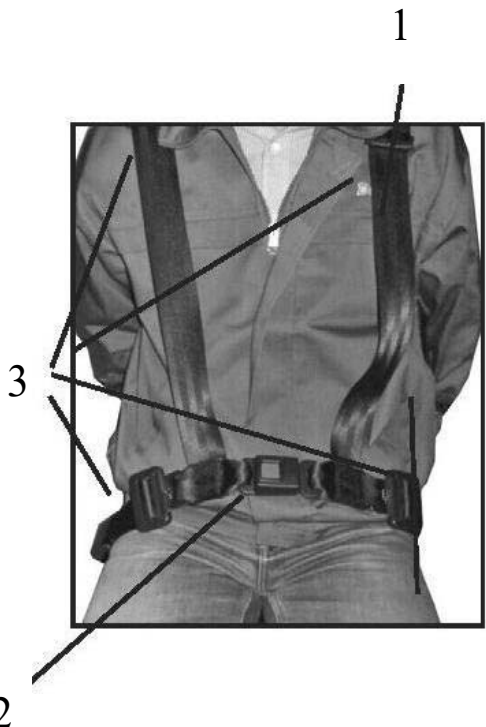

OPERATING THE GO KART

STARTING ENGINE

To start the engine

1. Place the fuel valve (1) in the "ON" right position.
2. If engine is cold, place the choke lever (2) in the "ON" left position.
3. Place the ON/OFF switch(3) , located on the steering column, in the "ON" position.
4. Pull the starter recoil cord(4) to start the engine.
5. Once engine has warmed up for a few minutes, place the choke lever (3) back to the "OFF" right position.

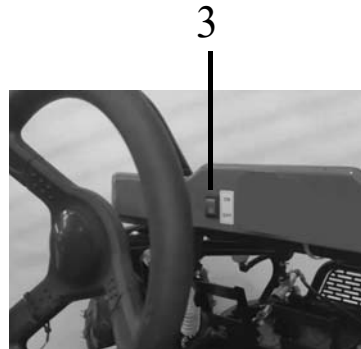
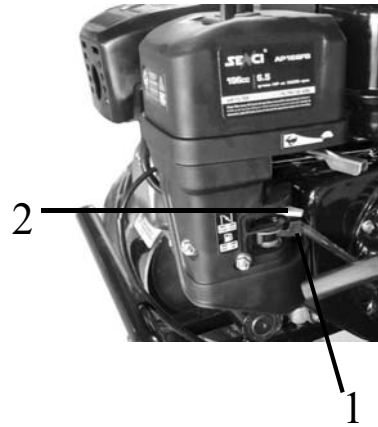

WARNING

starting or running the Go Kart in an enclosed area such as a garage or shed where there is no ventilation is hazardous.

Inhaling exhaust fumes from the Go-Kart can cause severe injury or death.

Never start or run the Go Kart in an inclosed environment where there is no ventilation. Always start and run outdoors.

OPERATING THE GO KART

STARTING OFF

1. start and warm up the engine according to the instructions in this manual.
2. Sit down in the go-kart and fasten seat belt. If riding with a passenger, make sure passenger has seat belt fastened also. If there is no passenger, make sure passenger seat belt is buckled and secured. A loose passenger seat belt could get tangled in moving parts.
3. Apply throttle gradually to start off. Practice driving the go-kart slowly on a flat dirt surface with no passengers. make sure that there is plenty of room for turning.

WARNING

Removing hands from the steering wheel and or feet from the floorboard while operating the Go.Kart could be hazardous.

Removing both or one hand from the steering wheel and/or feet from the floorboard could result in loss of control of the Go.Kart resulting in severe injury or death.

Always operate with both hands on the steering wheel and both feet on the floorboard while operating the Go-Kart.

WARNING

operating this Go-Kart at excessive speeds could be hazardous.

Driving at excessive speeds increases your chances of losing control of the Go-Kart, which could result in severe injury or death.

Always go at a speed that is proper for the terrain, visibility, operating conditions, operator skill, and operator experience. Always know the terrain before operating.

WARNING

Applying the gas pedal to full throttle when starting off could be hazardous.

The Go.Kart could lurch forward causing the front wheels to leave the ground causing loss of control.

Always open the throttle gradually when starting off from a stopped position.

WARNING

Braking while turning could be hazardous.

Braking while turning could cause the Go-Kart to slide out of control or flip over which could result in severe injury or death.

Before making a turn, slow down and release the brake.

OPERATING THE GO KART

CLIMBING A HILL

1. stop and evaluate the hill before attempting to climb. Make sure the hill is not too steep, the terrain is not loose or slippery and that there are no obstacles.
2. Approach the hill at a steady speed and maintain speed throughout the climb.
3. when approaching the top of the hill, slow down.

If it is determined that the Go Kart will not make it to the top of the hill.

1. Do not try to turn the Go Kart around while operating and come back down, this could cause the Go Kart to roll over.
2. slowly back the Go Kart down the hill while applying the brakes.

DESCENDING A HILL

To operate the Go Kart going down a hill, follow the instructions below.

1. stop and evaluate the hill before attempting to descend. Make sure the hill is not too steep, the terrain is not loose or slippery and that there are no obstacles.
2. Do not go down the hill on a sharp angle, this could cause the Go Kart to flip over. Instead, go straight down the hill. Apply the brakes on the way down.

TRAVERSING A HILL



WARNING

Traversing a hill could be hazardous.

Traversing a hill could result in losing control and flipping the Go Kart over.

This could result in severe injury or death.

Never attempt to traverse a hill that is too steep or has loose or slippery terrain.

OPERATING THE GO KART

SKIDDING OR SLIDING

In certain situations you may experience skidding or sliding even though the brakes are not applied. Follow the operating techniques listed below to regain control.

Front wheel begins to slide or skid:
To regain traction, let off the throttle, do not apply the brakes.

Rear wheels begin to slide or skid:
To regain traction, let off the throttle and brakes until control of the Go Kart is achieved, steer in the direction of the skid.



WARNING

skidding or sliding of the Go Kart could be hazardous.

skidding or sliding could result in the Go Kart sliding into an object or overturning suddenly by regaining traction resulting in severe injury or death.

Avoid skidding or sliding. Drive to stay in control.



WARNING

Applying the brakes hard on slippery surfaces could be hazardous.

Applying the brakes too hard on a slippery surface can cause the wheels to lock up and the Go Kart to slide out of control. The Go Kart could turn over or slide into an object. This could result in severe injury or death.

Gently apply the brakes when on a slippery surface.

OPERATING THE GO KART

OPERATING THROUGH WATER

operating through water can be hazardous, especially if it is fast moving. Make sure the water you are operating through is shallow and is not more than 5cm 2in deep. Before crossing any water look at the terrain entering and exiting the water, the terrain should have a gradual slope with no obstacles. The bottom of the river or pool of shallow water should be hard. If you do not know the terrain or are not sure about the bottom of the pool or river, do attempt to enter. Remember to protect the environment, do not enter a river or pool of water if doing so could damage the river bank or shore line.

Brakes need to be inspected, cleaned and replaced more often if Go Kart is used in muddy, wet or sandy conditions. Inspect the Go Kart brakes regularly, have a service center clean or replace as needed.

WARNING

Operating this Go Kart through fast or deep water could be hazardous;

Deep or fast moving water could cause the Go Kart to loose traction resulting in loss of control which could lead to severe injury or death.

Never operate this Go Kart in water that is more than 4in (10cm) deep. Never operate this Go Kart in fast moving water.

Always check brakes after operating through water, wet brakes can reduce stopping ability. Make sure brakes are dried out. The brakes can be dried out from friction by applying the brakes multiple times.

OPERATING THE GO KART

OPERATING IN COLD WEATHER . PRE RIDE INSPECTION

Brake and throttle linkages:

Cold weather requires additional pre-ride inspection of the Go Kart before operating. Inspect brake and throttle linkages making sure they operate freely and correctly. Ice and snow can cause these items to freeze. If the linkages are frozen, move the Go Kart to a warm area until these items thaw and work properly.

Frozen tires:

Check to make sure the Go Kart tires are not frozen to the ground, if they are, pour warm water around the tires to release. Do not attempt to break the Go Kart loose using engine power, this could damage the engine and drive train.

Brake inspection:

start engine and allow to warm up. Check the braking ability of the Go Kart by applying the brakes on level ground while traveling at a slow walking rate of speed. Make sure both front and rear brakes work properly. If the front, rear, or both sets of brakes do not work, take the Go Kart to a warm area to thaw out. once brakes are thawed, check again for proper operation, if they still do not work, take the Go Kart to a authorized service center. Do not attempt to operate the Go Kart with brakes that do not work correctly.

Preventive maintenance in cold weather operating is important. After operating in cold weather with snow, slush, water or ice, dry off the Go Kart including brake and throttle linkages. Apply the brakes several times making sure that the friction has dried off the brake pads and shoes. Cover the Go Kart with a protective cover so ice and snow cannot accumulate .

CAUTION

Using engine power to release wheels that are frozen to the ground could damage Go Kart.

Damage to engine and drive train may occur if attempting to use engine power to free frozen wheels.

Always make sure wheels move freely before starting the Go Kart in cold weather.



WARNING

operating the Go Kart with wet or frozen brakes could be hazardous.

wet or frozen brakes will increase stopping distance which could result in loss of control which could result in severe injury or death.

Always inspect the brakes before each ride by following the procedures in this manual.

OPERATING THE GO KART

LOAD GUIDELINES

Load guidelines including accessories:

Never exceed the maximum load capability of the Go Kart. This includes the weight of the operator and any cargo. This Go Kart is rated at 275 lbs(125kg) .

The luggage rack is rated at 11lbs. (5kg) .

Make sure all cargo is secure.

Distribute the weight of cargo evenly and low so the center of gravity is not adversely affected.

Do not add any accessory or cargo to the steering wheel that could impede vision or make the Go kart harder to steer.

Make sure accessories do not get in the way of any controls of the Go Kart.

Only carry cargo that is not bulky or too heavy.

Make sure all cargo is held securely in place,loose cargo can become a hazard.

while carrying cargo,go slow. Cargo can adversely affect handling at higher speeds .

Allow plenty of distance to stop while carrying cargo,the more weight on the Go kart,the longer distance it will take to stop.

AFTER MARKET PARTS

After market parts and accessories are available from many manufactures. Funrun cannot confirm the quality, safety or suitability of all the accessories available. when purchasing an accessory, use caution, the handling of the Go Kart could become affected. some accessories may make the Go Kart unsafe to operate. If you have a question about a modification or accessory, contact your dealer.

 WARNING	
Modifications or adding accessories could be hazardous.	
Modifications to the Go Kart, including adding accessories, could adversely affect the handling of the Go Kart causing an accident which could result in severe injury or death.	
Never Modify this Go Kart in anyway, including adding accessories, unless the modification is a genuine certified modification or accessory approved by the manufacture. Never modify the Go Kart with improper installation. Make sure to follow all instructions recommended in the certified modification. Use only genuine parts. For questions, contact your dealer.	

MAINTENANCE

For maintenance, your Go Kart maybe maintained by an authorized Furun service center or a repair shop of your choosing.

Following the proper maintenance procedures and time table for maintenance listed in this manual is important for the safety of the operator and the life span of the Go Kart. when operating in harsh conditions, such as water, mud and dust, the maintenance procedures should be performed more often.

 WARNING
Failing to perform the recommended maintenance on this Go Kart could be hazardous.
Failing to perform proper maintenance on this Go Kart could result in an accident
Always perform the recommended maintenance for the Go Kartas listed in this manual.

 WARNING
Performing maintenance and inspection while the engine is running could be hazardous.
Performing maintenance and inspections while the engine is running could result in getting body parts or clothing caught in moving parts, or could result in touching hot items which could result in severe injury.
shut off engine when perform. ing maintenance and inspection checks, with the exception checking the ignition switch and throttle.

CAUTION
Failing to perform recommended maintenance on this Go Kart could damage the Go Kart engine and components.
Always perform the recommended maintenance on this Go Kart as listed in this manual. Maintenance will need to be performed more often if ridden in wet, muddy or dusty conditions.

CAUTION
Failing to use compatible parts with the original replacement parts could damage Go Kart.
Using parts that are of low quality could result in Go Kart breakdowns and reduce the useful life of the Go Kart.
Never use parts that are not compatible with the original parts.

MAINTENANCE

ITEM	First 5 hours of operation	Before each ride	Every 20 hours of operation or 1 month	Every 50 hours or 3 months	Every 100 hours or 6 months
Exhaust pipe nuts and muffler bolts	Tighten	Inspect	Tighten		
Air cleaner element	Inspect		Inspect		
Valve Clearance**					Inspect
spark Plug			Inspect		Replace
Fuel Line		Inspect			
Idle speed	Inspect		Inspect		
Condition of throttle and brake cables	Inspect	Inspect			
Engine oil	Replace	Inspect		Replace	
Drive Chain	Inspect drive chain before each ride. Clean and lubricate as necessary				
Brakes	Inspect		Inspect		
Brake hose	Inspect		Inspect		
Brake fluid	Inspect brake fluid level before each ride, if low, check brake pads for wear and brake lines and components for leaks. Replace brake fluid every 2 years.				
Tires		Inspect			
steering	Inspect		Inspect		
Front suspension	Inspect		Inspect		
Rear suspension	Inspect		Inspect		
Chassis nuts and bolts	Tighten	Inspect	Tighten		

**** Recommended to be performed by an authorized service center or service center of the owner's choosing.**

MAINTENANCE

AIR FILTER

The air cleaner element needs to be cleaned or replaced periodically see chart for cleaning/replace-ment intervals . The air filter element will need to be cleaned more often if Go Kart is ridden in muddy, wet, or dusty conditions. A clean air filter will help the Go Kart to run at peak performance allowing better gas mileage, more power and will protect the engine from the damaging effects of dirt entering the engine.

Air filter removal, inspection and cleaning instructions

1. Locate the air filter assembly(1)
2. Remove the Air filter assembly cover by removing the air filter cover knob (2) .
3. Remove the air filter element from the assembly by removing the wing nut (3) .
4. Clean foam element (4) from the paper air filter element (5) and clean foam element with mild soap and water. Rinse and squeeze out excess water and allow to dry. Note: If foam element (4) is damaged, replace.
5. Inspect the air filter paper element (5) for dirt and damage. If dirty, gently tap element on ground to remove any excess debris. Gently blow out element from the inside with compressed air. If element is too clogged or damaged for continued use, replace the element.
6. once cleaned or replaced, reinstall.

CAUTION

Clean air filter more frequently if Go Kart is driven in wet, muddy or dusty conditions.

Driving in the above conditions without cleaning frequently can plug up the air filter which can cause poor gas mileage, low power and cause damage to the engine.

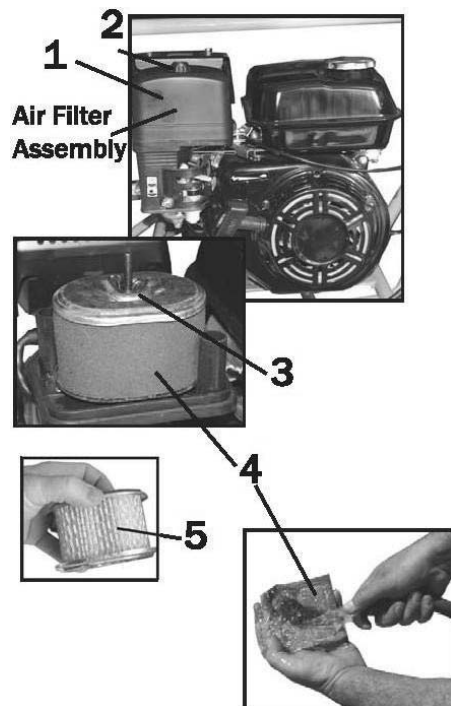

MAINTENANCE

SPARK PLUG

This Go Kart comes equipped with an F6TC spark plug.

To inspect the spark plug, remove the plug cap (1) then remove the spark plug (2) from the engine with the spark plug tool provided. Inspect the plug for carbon deposits and clean if necessary with a wire brush. If plug shows excessive carbon, replace the plug.

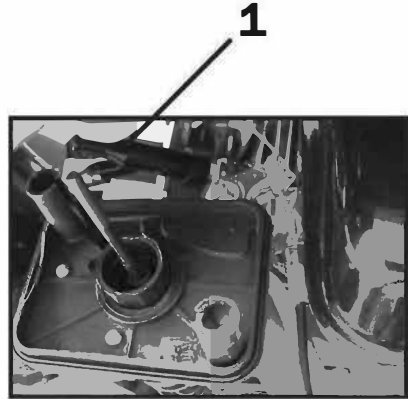

CAUTION

Dirt can damage the engine if it enters the spark plug hole.

Make sure the spark plug hole is covered after removing plug.

use a thickness feeler to inspect the spark plug gap (2). The spark plug gap should be 0.6 - 0.8mm (0.024 - 0.032in.)

Re-install the inspected plug or a new plug until finger tight. Finish tightening plug with a wrench. If spark plug is a new plug, tighten approximately 1/2 turn more with the wrench. If plug is an old plug, tighten approximately 1/8 turn more with a wrench.

F6TC



MAINTENANCE

ENGINE OIL

The proper amount and grade of engine oil will have a great impact on the life of the engine. Checking the oil daily and changing the oil as listed in the maintenance schedule is the most important maintenance procedure there is for the engine.

CHECKING THE ENGINE OIL

1. Make sure the Go Kart is on level ground
2. Check engine oil level by removing and looking at the oil plug/dipstick(1). oil should be close to the top of the serrated portion of the dipstick.
3. If engine oil is low, add oil until oil is at the top of the serrated portion of the dipstick. use the correct grade of oil as listed in this manual. Do not over or under fill engine with oil, this could damage the engine.

CHANGING THE ENGINE OIL

1. Make sure engine is warm before attempting to drain the oil. A warm engine will help the oil drain quicker.
2. Remove the oil fill plug(1)
3. Remove the drain bolt (2) located on the back bottom of the engine.
4. Allow the oil to drain in an appropriate container. Note: Dispose of oil at an oil reclaim facility.
5. Install the drain plug and fill with the appropriate type of oil as listed in this manual. This Go Kart requires 0.47qt.(0.45L)of engine oil.

6. Re- install fill cap, start engine and allow to run for a few minutes, Re-check oil level and fill accordingly.

WARNING

New and used oil can be hazardous

Children and pets can be harmed by swallowing new or used oil. Continuous contact with used engine oil has been found to cause skin cancer in laboratory animals

Always keep new or used oil away from children and pets.

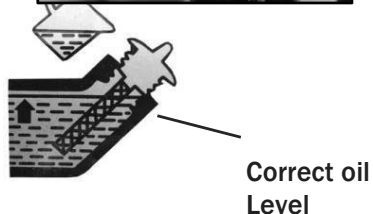
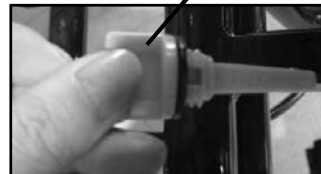
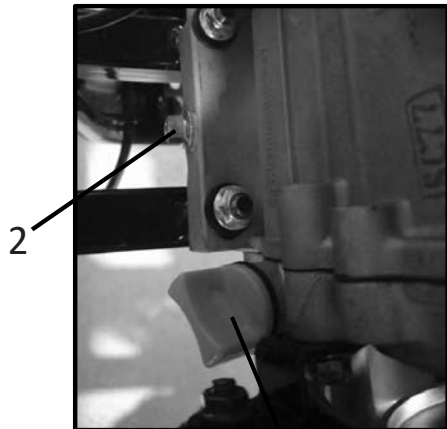

MAINTENANCE

FUEL HOSE INSPECTION

Inspect the fuel hose(1) for any cracks or leaks and make sure all clamps are in place. Replace the fuel hose if any defects are found.



1

BRAKES

This Go Kart is equipped with rear hydraulic disk brakes

WARNING

Failing to inspect brakes before each use could be hazardous

Inspect brakes before each use according to the Pre-ride check list, make sure to follow the maintenance schedule and procedures.

BRAKE FLUID INSPECTION

Check the brake fluid level(2) for rear brakes. If fluid level is below the lower mark, inspect the brake hoses(3) for leaks or cracks. If there are no leaks, inspect the brake pads for excessive wear. If brake pads are worn, take to a service center for replacement.

To add brake fluid, remove the lid (4) . use only DOT3 or DOT4 brake fluid.

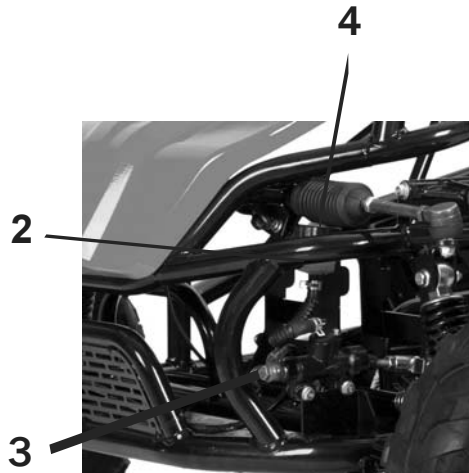

MAINTENANCE

Torque Converter Cleaning and lubrication

To help ensure maximum life out of the Torque Converter. It is important to clean and lubricate the front drive of the Torque Converter after every 10 hours of operation. To Clean and lubricate, follow the instructions below.

1. Make sure engine is not running and that the engine and Torque Converter has had time to cool.
2. Remove Torque Converter cover (1) .
3. Remove front drive (2) and take apart.
4. Clean front drive by spraying with a carburetor or brake cleaner and wiping dry with a rag. using a graphite type dry lubricant, sparingly lubricate inner components.
5. RE-INSTALL THE TORQUE CONVERTER COVER BEFORE STARING OR OPERATING THE GO-KART.

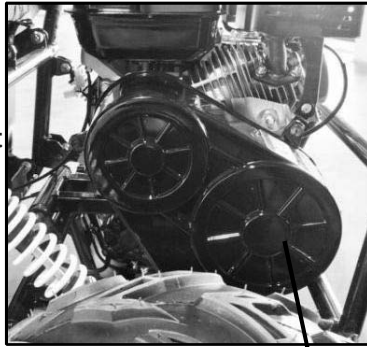

1



2

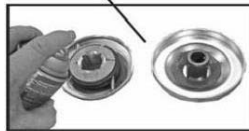

WARNING

Performing maintenance and inspection on the Torque Converter while the engine is running could be hazardous. Performing maintenance and inspection on the Torque Converter while the engine is running could result in getting body parts or clothing caught in moving parts, or could result in touching hot items which could result in severe injury



WARNING

operating the Go-Kart without the Torque Converter cover in place could be Hazardous.

operating the Go-Kart without the Torque converter cover could result in getting body parts or loose clothing caught in moving parts which could result in severe injury.

Never start or operate the Go-Kart without the Torque Converter cover in place.

MAINTENANCE

Chain and sprocket inspection

Inspect drive chain for wear, rust, bound links, proper lubrication and proper tension.

If drive chain has a problem, correct or replace. Contact a service center for chain replacement.

A worn drive chain could also mean the sprockets may be worn. Look for the following on sprockets(1) : worn teeth, broken or damaged teeth, loose sprocket mounting nuts.

If sprockets show signs of wear, contact a service center for replacement.

Chain Lubrication

Lubricating the chain before each ride will help to ensure maximum life of the chain and sprockets.

Instructions for cleaning and chain lubrication:

1. Clean chain with a chain cleaner or a cleaning lubricant such as WD40.
2. Lubricate chain with chain lube.

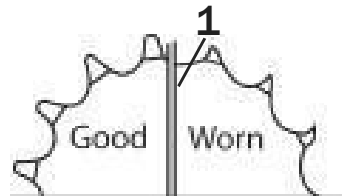

Chain Tension

⚠ WARNING
Checking chain tension while the engine is running can cause serious injury.
Always make sure engine is off before checking drive chain tension.

Check tension of drive chain (2) , chain tension slack should be 0.2 - 0.4in 5 - 10mm

Chain tension (slack) Adjustment

1. Loosen nuts (3) on Chain tensioner.
2. Adjust chain tension by turning tensioner nuts (4) . Clockwise will tighten the chain. Counter clockwise will loosen the chain.
3. once the chain is at the correct tension re-tighten nut (3) .
4. Re-check chain tension.

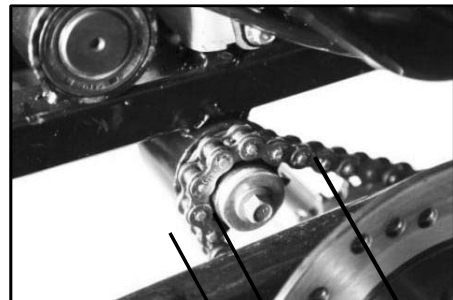

5-10mm
0.2-0.4in

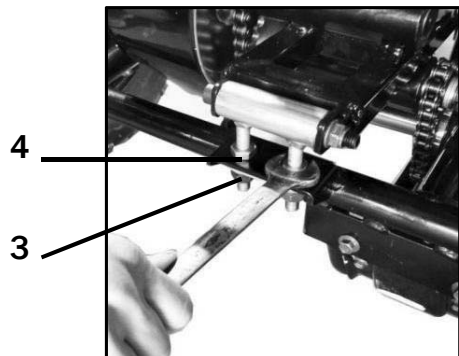

MAINTENANCE

TIRES

Inspect tires before each ride, this should include the following:

1. Inspect for cracks or leaks
2. Inspect tread depth. If tread depth is below 4mm .16 in. replace the tire.
3. Check tire pressure. Incorrect tire pressure can affect the handling, operator, comfort, steering, tire life and traction.

Tire pressure

Front tires: 7-9psi 48-62kpa

Rear tires: 7-9psi 48-62kpa

Tire size:

Front tires: 145/70-6

Rear Tires: 16/8-7

REPLACING TIRES

Always replace tires with type and size listed in this manual.

Always use the correct tools when replacing tires. The bead and sometimes the rim can be damaged by using the wrong type of tools. It is usually best to have tires replaced by an authorized service center. Service centers have the correct equipment and expertise to change tires without causing damage.

Punctures to tires can usually be repaired by using plug type patches. Plug type patches cannot repair tires that have been cut. If the tire has been cut or has a puncture in a location or size that cannot be repaired, replace the tire.

Be prepared for flat tires, always carry a plug type patch kit and air pump with you.



Minimum tread
4mm .16 in.



! WARNING

operating this Go Kart with worn tires could be hazardous. operating this Go Kart with worn tires will reduce traction which could result in an accident.

Never operate this Go Kart with tires that have a tread depth of less than 4mm (0.16 in.).

! WARNING

operating this Go Kart with improper tire sizes or pressure could be hazardous. operating this Go Kart with improper tire sizes or pressure could result in loss of control of the Go Kart which could result in an accident.

Never operate this Go Kart with improper tire sizes or pressure.

MAINTENANCE

STORAGE

If the Go-Kart is left unused for an extended period of time proper storage maintenance is required.

1. Wash Go-Kart thoroughly, then wax painted parts with a non abrasive auto wax. Coat vinyl seat and rubber parts with a vinyl/rubber protect ant. Note: Keep water away from air intake and muffler outlet while washing to avoid water from entering the engine and/or components.

2. Drain carburetor by placing fuel valve (1) to the off left position and opening the drain screw (2) . Allow all fuel to drain from the carburetor. once fuel is drained, re-tighten drain screw (2) .

Note: Make sure to drain fuel in a proper storage container.

3. Fill fuel tank to full with gasoline mixed with fuel stabilizer as recommended by the fuel stabilizer manufacture.

Note: Fuel stabilizer can be purchased at most motorcycle shops and auto parts stores.

4. Remove spark plug and proof tablespoon of motor oil in the spark plug hole. Re-install spark plug.

5. Place the starter switch to the off position and pull the start recoil cord a few times. This is to coat the inside cylinder head with oil.

6. Fill tires with correct air pressure.

7. If possible, store Go-Kart in a shed or garage with a cover to protect from dust, dirt and humidity. If the Go-Kart must be stored outdoors, cover completely with a good water proof cover.

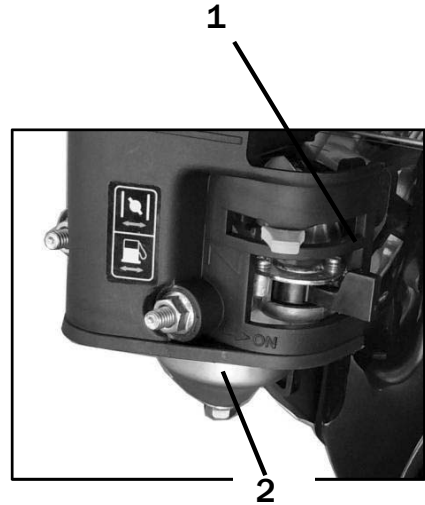

Returning to service

1. Wash Go-Kart thoroughly. Note: Keep water away from air intake and muffler outlet while washing to avoid water from entering the engine and/or components.

2. Drain engine oil and replace with fresh clean oil as listed in this manual.

3. Review this owner's manual and follow the pre-ride inspection procedures.

4. start engine by following the starting procedures in this manual.

MAINTENANCE

WASHING THE GO KART

1. Wash mud and dirt off Go Kart with low water pressure from a hose.
2. Wash Go Kart using a mild detergent or car soap using as ponge, soft rag or brush. Do not use any cleaning materials that could scratch the Go Kart.

Note: Be careful not to allow water to enter the muffler outlet, air filter intake, brake cables or switches.

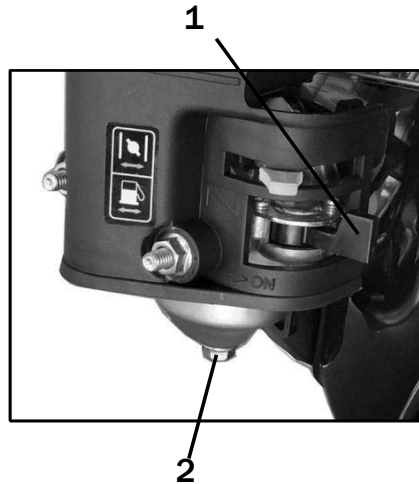

TRANSPORTING

1. Turn the Fuel valve (1) to the "OFF" position. Open the fuel drain screw (2) . Allow all fuel to drain from the carburetor. once fuel is drained, re-tighten drain screw (2) .
- Note: Make sure to drain fuel in a proper storage container.

3. Transport the Go-Kart in the upright position tied down securely.

TROUBLE SHOOTING

Trouble	Possible cause	solution
<p>Engine will not start.</p>	<ul style="list-style-type: none"> ◦ Air filter dirty ◦ Low fuel stale old or contaminated fuel. ◦ Fuel valve is defective ◦ Clogged fuel filter ◦ Loose spark plug ◦ spark plug fouled or defective. ◦ spark plug gap is incorrect ◦ spark plug cap is not attached ◦ Trying to start engine while applying throttle ◦ Low compression ◦ Problem with the electrical system 	<ul style="list-style-type: none"> ◦ Clean or replace air filter ◦ Fill with fresh fuel ◦ Have a service center flush and fill with fresh fuel. ◦ Replace fuel valve ◦ Replace fuel filter ◦ Tighten spark plug ◦ Clean or replace plug ◦ Gap the plug ◦ Attach spark plug cap ◦ Do not apply throttle while starting engine ◦ Take to a servicecenter for repair ◦ Take to a service center for diagnostics and repair
<p>Engine stalls or runs erratically</p>	<ul style="list-style-type: none"> ◦ Air filter dirty ◦ Low fuel stale or contaminated fuel ◦ spark plug is fouled or defective ◦ spark plug gap is incorrect ◦ spark plug cap is loose ◦ Carburetor is clogged or has water in it ◦ Idle is not adjusted properly ◦ Problem with the electrical system ◦ Low compression 	<ul style="list-style-type: none"> ◦ Clean or replace air filter ◦ Fill with fresh fuel ◦ Have a service center flush and fill with fresh fuel. ◦ Clean or replace plug ◦ Gap the plug ◦ secure the spark plug cap ◦ Take to a service center ◦ Take to a service center ◦ Take to a service center for diagnostics and repair ◦ Take to a servicecenter for repair

TORQUE SPECIFICATIONS

FASTNER THREAD SIZE	TORQUE (ft.lbs.)/(in.lbs.)	TORQUE (nm)
5 mm bolts and nuts	39/52 in.lbs.	4.5/6 nm
6mm bolts and nuts	69/104 in. lbs.	8/12 nm
8mm bolts and nuts	13/18 ft.lbs.	18/25 nm
10 mm bolts and nuts	22/29 ft.lbs.	30/40 nm
12 mm bolts and nuts	36/43 ft.lbs.	50/60 nm
4 mm screws	22/30 in.lbs.	2.5/3.4 nm
5mm screws	30/43 in.lbs.	3.5/5 nm
6 mm hex bolts	87/121 in.lbs.	10/14 nm
8 mm hex bolts	17/22 ft.lbs.	24/30 nm
10 mm hex bolts	25/32 ft.lbs.	35/45 nm

SPECIFICATIONS

<p style="text-align: center;"><u>Engine</u></p> <p>Displacement 212cc</p> <p>Max Power 5.3hp/3600rpm</p> <p>Max Torque 8.58lb/ft (12Nm)</p> <p style="text-align: center;">@ 2500rpm</p> <p>Bore × stroke 2.75x2.17 inch</p> <p style="text-align: center;">(70mm x 55mm)</p> <p>starting Manual Pull start</p> <p>spark Plug Type F6TC</p> <p>Cooling Air cooled</p> <p>Engine oil Capacity 0.47qt. (0.45L)</p> <p>Engine oil Type SAE 15W-30</p> <p>Fuel Capacity 0.95Gal. (3.6L)</p> <p>Ignition Type T.C.I</p> <p>Number of Cylinder single</p> <p>Combustion Cycle 4.stroke</p> <p>Top speed 23.9mph (38km/h)</p> <p style="text-align: center;"><u>Transmission</u></p> <p>Type Automatic</p> <p>CVT Torque Converter</p> <p>Drive system Type Chain</p> <p>Drive Dual wheel</p> <p>Gear Ratio Automatic</p> <p style="text-align: center;"><u>suspension</u></p> <p>Front Type Dual A-Arm</p> <p style="text-align: center;">Adjustable shocks</p> <p>Rear Type Dual shocks</p> <p style="text-align: center;">Adjustable shocks</p>	<p style="text-align: center;"><u>Braking</u></p> <p>Rear Brake Hydraulic disk</p> <p style="text-align: center;"><u>Tires</u></p> <p>Front Tire size 145/70-6</p> <p>Rear Tire size 16X8-7</p> <p>Tire pressure 7.9psi(48.62kpa)</p> <p style="text-align: center;"><u>Dimensions and weights</u></p> <p>Length 68.3in. (1735mm)</p> <p>Height 47.6in. (1210mm)</p> <p>width 45.3in. (1150mm)</p> <p>wheelbase 49.2in.(1250mm)</p> <p>Gd. Clearance 3.14in. (80mm)</p> <p>Vehicle wt. 242 lbs. (110kg)</p> <p>weight Cap. 275lbs. (125kg)</p> <p>Rack Cap. 11lbs (5kg)</p> <p style="text-align: center;"><u>Fuel</u></p> <p>Gas Tank Capacity 0.95gal.(3.6L)</p> <p>Fuel type Unleaded 90 octane</p> <p style="text-align: center;">or higher</p>
---	---

VEHICLE IDENTIFICATION NUMBER LOCATION



VIN #

The Vehicle identification number is needed when calling for parts, service center help or when registering your Go Kart. Locate the number and list the number below for your reference.

The 17 digit Vehicle Identification Number VIN is stamped on the right side of the go-kart on the metal frame.

Vehicle Identification
Number:

--	--	--	--	--	--	--	--	--	--	--	--	--	--	--	--	--	--